

User Guide For Implementing ECBC in Data Centers

Complying With the Energy Conservation Building Code (2017) and Higher Rating Levels

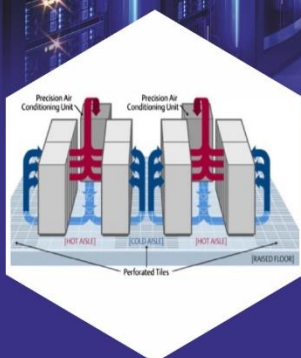

Room Cooling

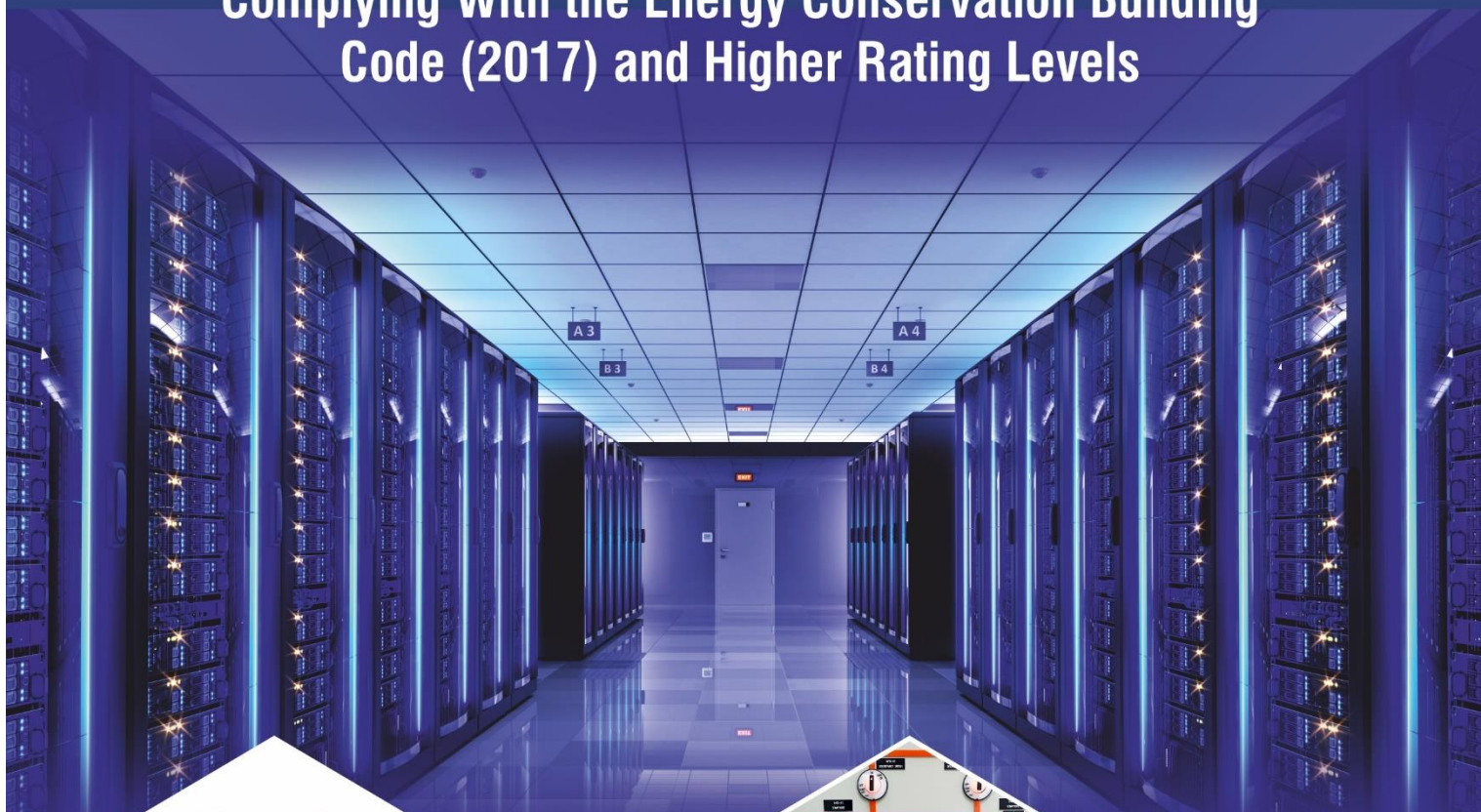

Chiller Plant

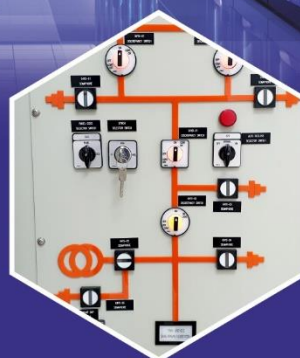

Electrical System



IT Hardware &
Management



Confederation of Indian Industry
125 Years - Since 1895



USER GUIDE FOR IMPLEMENTING ECBC IN DATA CENTERS

Complying with the Energy Conservation Building
Code (2017) and Higher Rating Levels

Lawrence Berkeley National Laboratory

Dale Sartor, Steve Greenberg, Kim Traber, Hannah Stratton and Ian Hoffman

Indian Green Building Council – Confederation of Indian Industry

S Karthikeyan, Shivraj Dhaka, Himanshu Prajapati and Yasin Khan

Copyright Notice

User Guide for Implementing ECBC 2017 in Data Centers © 2021 Confederation of Indian Industry – Indian Green Building Council, and the Lawrence Berkeley National Laboratory. This manuscript has been co-authored by staff of Lawrence Berkeley National Laboratory and the Confederation of Indian Industry (CII) – Indian Green Building Council (IGBC) under sponsorship of the U.S. Department of Energy. The U.S. Government retains, and the publisher, by accepting the article for publication, acknowledges, that the U.S. Government retains a nonexclusive, paid-up, irrevocable, worldwide license to publish or reproduce the published form of this manuscript, or allow others to do so, for U.S. Government purposes.

Acknowledgements

This work was performed under the aegis of the U.S.-India Strategic Energy Partnership and supported by the U.S. Department of State through the U.S. Department of Energy under Contract No. DE-AC02-05CH11231 with the Lawrence Berkeley National Laboratory. The authors also thank the Indian Bureau of Energy Efficiency and we deeply appreciate the contributions of the CII Advisory Group for this guide:

Task Force Leads/Committee Chairmen:

- ❖ **Chiller Plant**
Mr P.C. Lohia, Senior Vice President - HVAC, Reliance Industries Ltd.
- ❖ **Room Cooling**
Mr Raghuveer Singh, Director -Thermal Management, Vertiv Energy Private Limited
- ❖ **Electrical Systems**
Mr Pritam Goyal, Senior Program Manager-Infrastructure, Strategy and Planning, Microsoft
- ❖ **IT Hardware & Management**
Mr Vivek Rajendran, Director, Software Engineering, Dell EMC, Infrastructure Solutions Group

Advisory Group Members

Mr Syed Mohamed Beary, CMD, Bearys Group & Chairman, IGBC Bangalore Chapter
Mr Ashish Dandekar, Council Member, Gerson Lehrman Group
Mr Ashish Rakheja, Managing Partner, AEON
Mr Angelo Barboza, GM & Head APAC Region, Rittal India
Mr B. Rajput, Senior Technical Director, National Information Center
Mr Biju Jacob John, AVP – Solutions Engineering, Netmagic (An NTT Company)
Mr Chaitanya Tamhankar, Legrand
Mr Hiren Shah, General Manager, Sterling & Wilson Pvt Ltd
Mr John Booth, Managing Director, Carbon3IT Ltd.
Dr (Ms) Kanwal Sujit, CEO, Terralve Envirotech Pvt Ltd
Mr Kiran A J, Regional Manager – Infrastructure, Infosys, Bangalore
Wing Commander Mallikarjun V Patil (Retd), CEO, Apt Data Center Consultants India LLP
Mr Manik Kapoor, Head Server & Data Center Infrastructure, Asia Pacific & Japan, AMD
Mr Manoj Kapil, Practice Head, Data Centers and O&M Services, Wipro Ltd.
Mr Mario Dias, Manager-Fac Operations, Workplace Resources, NetApp
Mr Murari Sinhal, Gr. Sr Vice President, Reliance Industries Limited

Mr Mahesh Trivedi, Sr. Executive Vice President, Netmagic - NTT
Mr Mayank Srivastav, Director Data Center Practice, Schneider Electric
Mr N K Singh, Senior Director, Business Development - South Asia, Uptime Institute
Mr Pankaj R. Wadhwa, Managing Director, Vastunidhi Architects
Mr Punit Desai, Regional Manager – Infrastructure, Infosys
Mr Pushpendra Pandey, Program Manager, IBM Global Technology Services
Mr R. Rajkumar, VP-IT, Infosys Limited
Mr Rajkumar Kambar, DC Manager Asia – Intel
Mr Ranvijay Roy, Consultant, Wipro Limited
Mr Saurabh Diddi, Director, Bureau of Energy Efficiency Govt. of India
Ms Shalini Singh, Senior Sustainability Manager, Office of the CTO, VMware
Ms Shatakshi Suman, Assistant Project Manager (ECBC), Bureau of Energy Efficiency
Mr Shashi Bhushan Prasad, Vice President - Projects, STT GDC
Mr K M Shankar, **Associate Director** - Data Center Operations, STT Global Data Centers India
Mr Shekhar Dasgupta, Founder, GreenField Software Private Ltd.
Mr Shirang Deshpande, Country Head-Data Center Business (India), Vertiv Energy
Mr Shubham Agarwal, Manager, Green Initiative, Infosys, Bangalore
Mr Siddharth Jain, Managing Director, EPI-India
Mr Vinit Gupta, Country Head Marketing, Numeric
Mr Vinod Kulkarni, Facility Manager, NetApp India Private Limited

Project Team: Lawrence Berkeley National Laboratory (LBNL) US

Mr Dale Sartor, PE, Staff Engineer
Mr Steve Greenberg, PE, Facilities Energy Management Engineer
Ms Hannah Stratton, Project Manager
Mr Ian Hoffman, Senior Scientific Engineering Associate
Mr Kim Traber, Principal, Traber Engineers

Project Team: Confederation of Indian Industries (CII)

Mr S. Srinivas, Principal Advisor, CII-GBC Hyderabad
Mr S. Karthikeyan, Principal Counsellor, CII-GBC Hyderabad
Dr Shivraj Dhaka, Counsellor, CII-GBC Hyderabad
Mr Himanshu Prajapati, Executive Engineer, CII-GBC Hyderabad
Mr Yasin Khan, Associate Counsellor, CII-GBC Hyderabad

Disclaimer

This document was prepared as an account of work sponsored in part by the United States Government. While this document is believed to contain correct information, neither the United States Government nor any agency thereof, nor The Regents of the University of California, nor any of their employees, makes any warranty, express or implied, or assumes any legal responsibility for the accuracy, completeness, or usefulness of any information, apparatus, product, or process disclosed, or represents that its use would not infringe privately owned rights. Reference herein to any specific commercial product, process, or service by its trade name, trademark, manufacturer, or otherwise, does not necessarily constitute or imply its endorsement, recommendation or favoring by the United States Government or any agency thereof, or The Regents of the University of California. The views and opinions of authors expressed herein do not necessarily state or reflect those of the United States Government or any agency thereof, or The Regents of the University of California.

Table of Contents

Copyright Notice	2
Acknowledgements	2
Disclaimer	3
1. Introduction	5
2. Room Cooling	8
CRAC Efficiency.....	8
Air Management.....	14
Temperature & Humidity Control	20
Fan Systems	24
Economizers	27
3. Chiller Plant	31
Chillers	31
Cooling Towers	34
Pump Systems	36
Chiller Plant - Performance Approach	39
4. Electrical System	41
Uninterruptible Power Supply (UPS)	41
Diesel Generators	45
Metering & Monitoring	47
5. IT Hardware & System Management	52
IT Hardware	52
Systems Management.....	58
6. Additional Resources	62
Appendix A: Glossary	66

1. Introduction

This guide serves as a supplement to the Energy Conservation Building Code (ECBC) 2017, issued by the Bureau of Energy Efficiency (BEE), Ministry of Power ([November 2019 version](#)). The ECBC is intended to provide requirements for design and construction of energy-efficient buildings in India, including data centers.

The purpose of this supplemental guide is to help users identify standards in the ECBC 2017 that pertain specifically to data centers and to offer notes and suggestions for implementation. Additionally, this guide directs users to other resources, including those from the U.S. Department of Energy's Lawrence Berkeley National Laboratory's Center of Expertise (CoE) for Energy Efficiency in Data Centers (<https://datacenters.lbl.gov/>). The CoE website provides helpful tools, reports and other resources that can assist users in achieving desired energy efficiency results.

The ECBC provides three levels of compliance ("ECBC Compliant", "ECBC+", and "SuperECBC") and this guide includes standards for each level. In the case of energy efficiency opportunities for which the BEE did not define requirements for compliance, additional recommended requirements are provided. This guide aims to help users identify which ECBC tier they seek to achieve, as well as provide guidance and best practice recommendations.

This guide covers energy efficiency opportunities under four broad categories:

1. Room Cooling
2. Chiller Plant
3. Electrical Systems
4. IT Hardware & Management

Each category contains sections for various measures (e.g., Air Management under Room Cooling). Each section provides guidance, tips, and resources to help users achieve a given efficiency level for the measure. Each section begins with a table listing the requirements for each of three efficiency levels.

- **Level I:** ECBC Compliant and any recommended additional requirements.
- **Level II:** ECBC+ and any recommended additional requirements.
- **Level III:** SuperECBC and any recommended additional requirements.

Note that Level II and Level III requirements build on lower-level requirements and only higher efficiency levels or additional requirements are specified. That is, all Level II criteria inherently include, and are incrementally more efficient than, Level I requirements; Level III requirements are incrementally more efficient than those in Level II. The table below provides an example of the format for each of the sections that follow.

Table Illustrating Compliance Levels

Level I	Level II	Level III
<p><u>ECBC Compliant</u></p> <p>Reference to ECBC 2017 Section Number if applicable.</p> <p>✓ Listed requirements to achieve ECBC Compliant level.</p> <p><u>Recommended Additional Requirements</u></p> <p>Additional requirements (if any) to achieve this level that are not directly addressed by ECBC 2017.</p>	<p><u>ECBC+</u></p> <p>Reference to ECBC 2017 Section Number if applicable.</p> <p>✓ Listed requirements to achieve ECBC+ level.</p> <p><u>Recommended Additional Requirements</u></p> <p>Additional requirements (if any) to achieve this level that are not directly addressed by ECBC 2017 or at Level I.</p>	<p><u>SuperECBC</u></p> <p>Reference to ECBC 2017 Section Number if applicable.</p> <p>✓ Listed requirements to achieve SuperECBC level.</p> <p><u>Recommended Additional Requirements</u></p> <p>Additional requirements (if any) to achieve this level that are not directly addressed by ECBC 2017 or at Level I or II.</p>

Each table is followed by Tips and Best Practices for meeting or exceeding the requirements and achieving operational efficiencies. Each section also includes Resources or Citations to various sources of information on the measures, their energy performance or implementation.

Performance Approach

The advisory group and sponsors of this guide considered an alternative, strictly performance-based path to compliance at each level (ECBC, ECBC+ and SuperECBC). A number of metrics are available for measuring energy performance of data centers. None are ideal in every respect. The Power Usage Effectiveness (PUE) metric remains the most popular and is defined as follows:

$$PUE = \frac{\text{Total Facility Energy}}{\text{IT Equipment Energy}}$$

The diversity of data center configurations, insufficient data and other difficulties in assigning technically defensible and equitable PUEs for each level, makes this an insurmountable task at this time. As data are collected, setting realistic performance targets may be revisited in future versions of this guide. For now, the team has drawn on its expert judgment and anecdotal evidence from deployed data centers to estimate the expected PUEs that best approximate energy performance at each of the three levels, as illustrated by Figure 1.

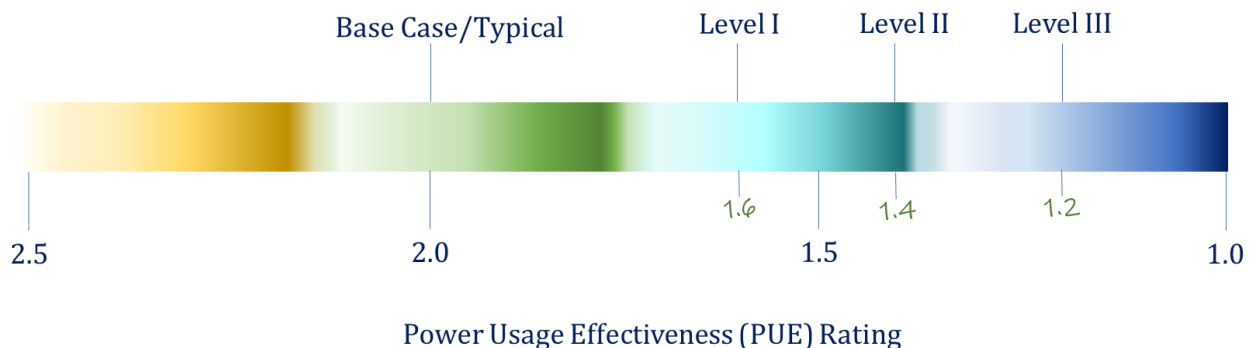

Figure 1. Estimated Power Usage Effectiveness for adherence to the Level I (ECBC), Level II (ECBC+), and Level III (SuperECBC).

Other Performance Factors

Best Practice Design and Operations

Throughout the guide the importance of good operations as well as good design is emphasized. Good (or poor) operation significantly impacts actual PUE performance.

Right Sizing

Another important consideration is the design vs. the actual IT load. Often data center mechanical and electrical systems are oversized to accommodate future load growth (or unknown loads) as well as to provide high levels of redundancy. This often results in poorly performing systems especially from an efficiency standpoint. Designing scalable systems is strongly recommended. Such systems can reduce initial cost by only installing what is actually needed, improve energy performance, and allow for future growth if and when the load develops. To demonstrate PUE for a new data center, a simulation report should be generated at 33%, 66% and 100% of the design load for the data center.

2. Room Cooling

The measure types in this section address cooling at the data center room level.

CRAC Efficiency



ECBC 2017 formally adopted energy efficiency requirements for Computer Room Air Conditioners (CRACs) and condensing units serving data centers.

Level I	Level II	Level III
<p><u>ECBC Compliant</u></p> <p>ECBC 2017 Section 5.2.2.4: Air Conditioning and Condensing Units Serving Computer Rooms</p> <ul style="list-style-type: none"> ✓ Minimum Net Sensible Coefficient of Performance (NSenCOP) rating of 2.5, regardless of capacity, for both downflow & upflow. <p><u>Recommended Additional Requirements</u></p> <ul style="list-style-type: none"> ✓ CRAC units shall be equipped with variable-speed fans 	<p><u>ECBC+</u></p> <p><u>Recommended Additional Requirements</u></p> <ul style="list-style-type: none"> ✓ Minimum Net Sensible Coefficient of Performance (NSenCOP) rating of 3.0, regardless of capacity or air flow direction. 	<p><u>SuperECBC</u></p> <p><u>Recommended Additional Requirements</u></p> <ul style="list-style-type: none"> ✓ CRAC units should not be used at Level III. Use systems that have higher levels of energy performance including the ability to utilize economizer cooling.

Tips and Best Practices

CRAC Efficiency

- Net sensible coefficient of performance (NSenCOP) is a ratio calculated by dividing the net sensible cooling capacity in watts by the total power input in watts (excluding reheaters and humidifiers) at any given set of rating conditions. The net sensible cooling capacity is the gross sensible capacity minus the energy dissipated into the cooled space by the fan system (from ASHRAE standard 127-2012 Method of Testing for Rating Computer and Data Processing Room Unitary Air Conditioners).
- A CRAC manufacturer's efficiency rating applies to the entire CRAC as a single package but does not include operation in economizer modes (required at Level II).
- The rating is determined by operating the CRAC at AHRI 1360/1361 for design input conditions (specific return air temperature, humidity and ambient temperature) in a laboratory setting.
- A manufacturer can achieve a rating with different choices and arrangement of the components (fans, motors, compressor, coils and air filters).
- The actual operating efficiency of a CRAC can be 3.5 NSenCOP or higher at higher return air temperature (i.e., 38°C).
- CRAC units should be designed to operate at return air temperature 38°C or above, meeting ASHRAE server inlet temperatures guideline (up to 27°C).
- Ideally CRACs should be configured for bottom discharge. Figure 2 compares a typical top-discharge CRAC with a typical bottom-discharge CRAC. It shows that a bottom-discharge CRAC generally has efficiency advantages over a top-discharge CRAC unit.

In the case of a bottom-discharge CRAC, a facility can elevate the operating temperature and improve efficiency (lower PUE). In a top-discharge CRAC unit, hot and cold air often mix, leading to inefficiency in the system. There are some applications where top-discharge configuration can be effective, so factors such as air effectiveness and rack configuration should be taken into account.

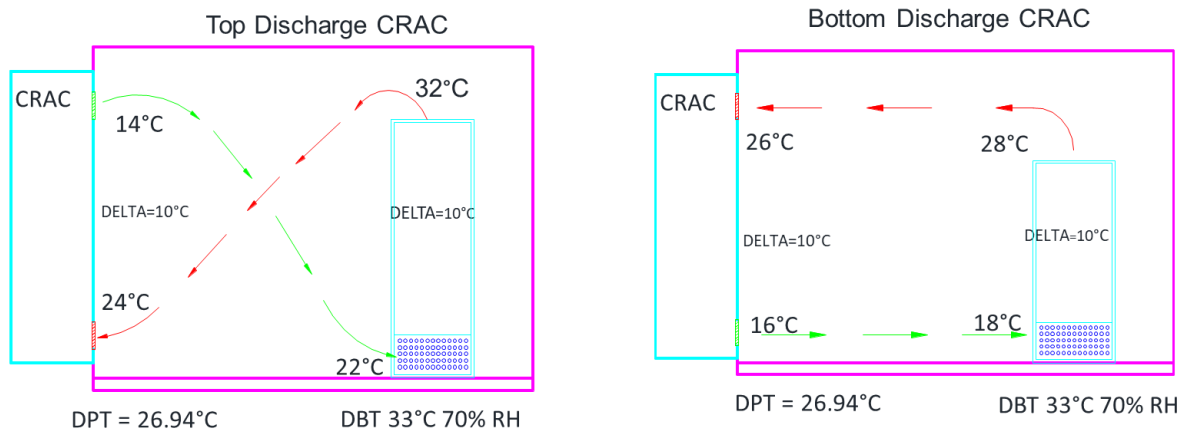

Figure 2. Top- and bottom-discharge computer room air-conditioning (CRAC) units

- CRAC/CRAH should have advance controls like Team mode, Sharing mode, Cascade mode etc., to enhance operational performance. User shall select the mode of operation based on their operating requirements.
- Use electronically commutated motor (ECM) driven plug fans with horizontal underfloor air distribution. Plug fans (also known as plenum fans) discharge air into a plenum rather than a duct. They are direct-drive. A motorized impeller is an integrated fan and motor assembly that typically uses an ECM and a plug fan. ECMs inherently provide variable-speed capability which can add additional saving.

An independent lab (ETL) evaluated the energy saving potential of three different fan configurations, as shown in Figure 3. Underfloor placement of fans offers maximum power savings (5.5 kW of demand compared to a conventional case wherein 8.6 kW is consumed).

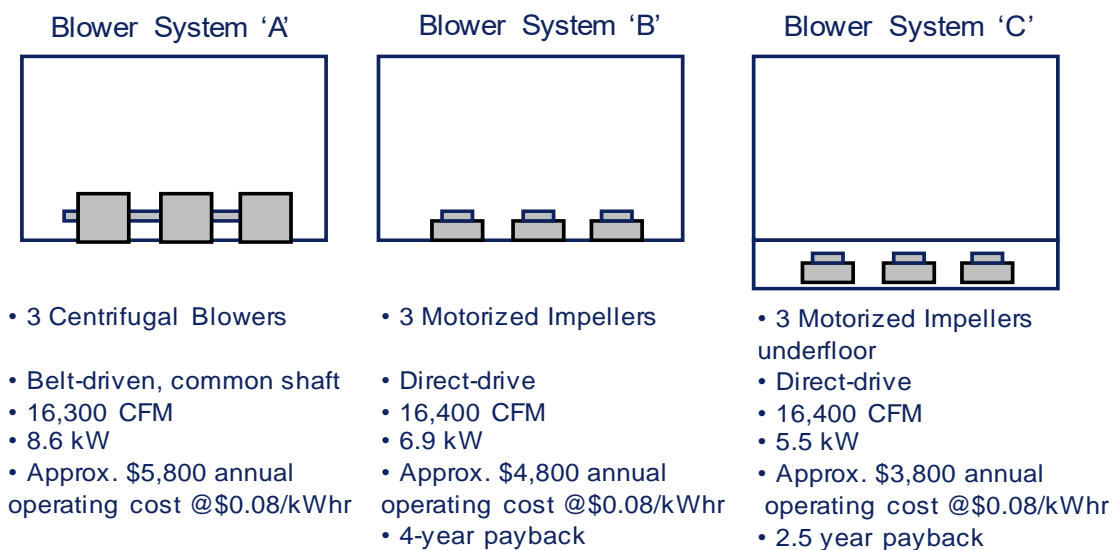

Figure 3. Blower configuration test results (Source: Vertiv)

- Consider variable capacity compressors. In addition to variable fan speed control for CRACs, variable capacity compressors are recommended to maximize the energy saving during part load operation. As the compressor drives the power consumption for any DX based CRAC, variable capacity compressors provide better energy efficiency by matching the CRAC output with the IT load. Refer to Figure 4 and Figure 5 on better temperature control and best part load efficiency for variable capacity compressor versus fixed speed compressor operation.

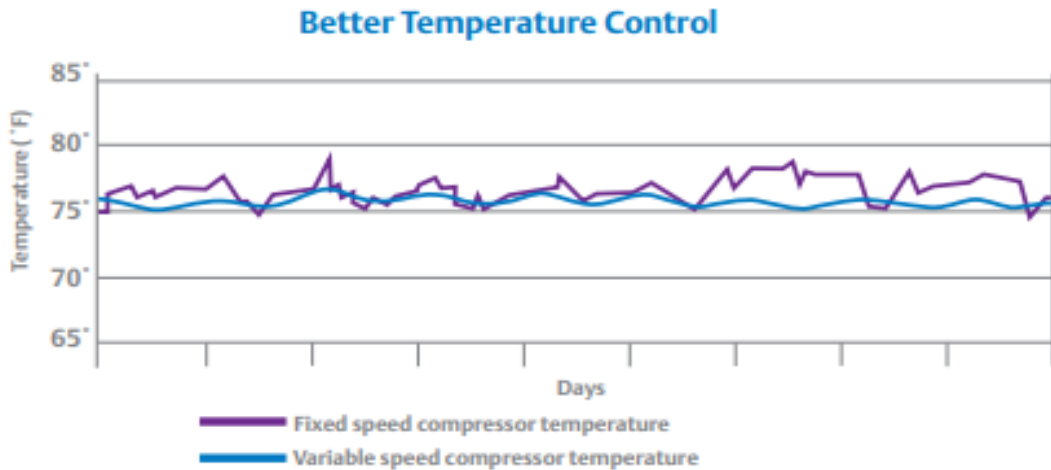

Figure 4 : Improved temperature control with variable speed compressor (Source: Emerson, [Link](#))

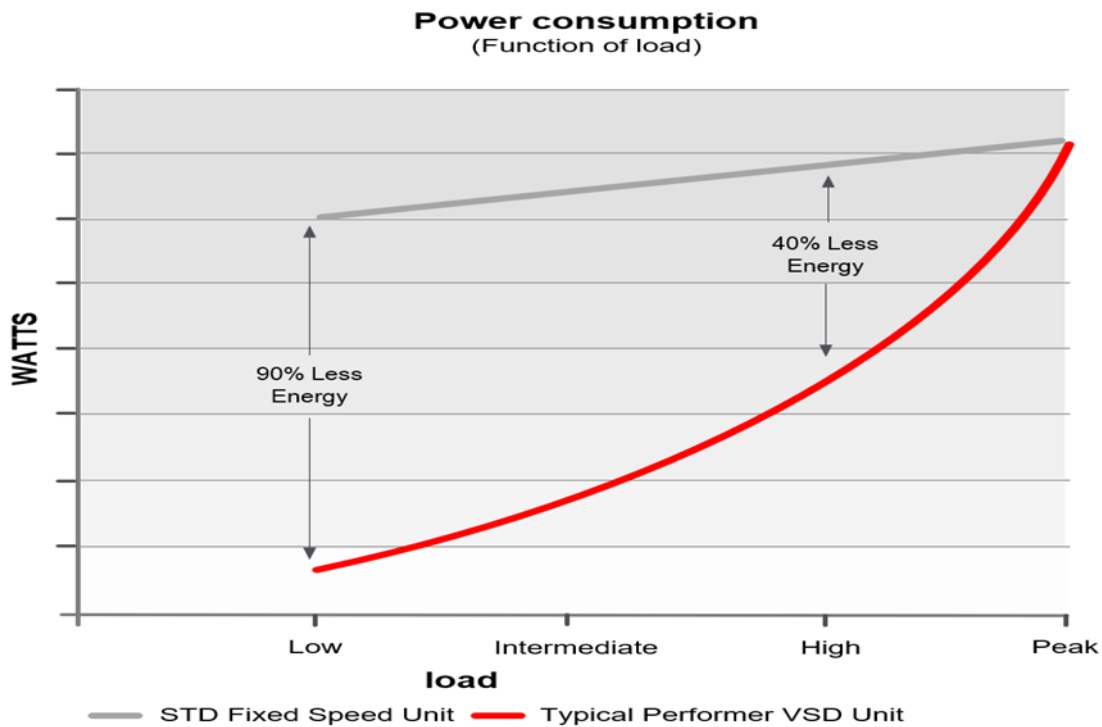

Figure 5: Part load efficiency comparison for variable speed compressor vs fixed speed compressor (Source: Danfoss, [Link](#))

- Heat rejection – it is recommended to use vertical discharge type air-cooled condensers to minimize the mixing of hot discharge air and cooler ambient air when multiple condensers are installed. Avoiding air mixing results in better performance.

CRAC Options

- Some options – such as auxiliary water coils or refrigerant based economizers – may offer significant efficiency gains that are not reflected in the rating. CRAC efficiency ratings are typically determined with all options removed.
- Consider water-cooled CRAC condensers instead of air-cooled. This can be a good transition technology to more efficient warm-water cooling systems such as rear door heat exchangers and liquid to the chip cooling options.
- Integrated controls can be implemented to optimize CRAC operation, for example to reduce or prevent simultaneous dehumidification and humidification.
- See Economizer section for further requirements and recommendations for economizing.

CRAC Retrofits

- For already-installed CRACs, some manufacturers offer efficiency retrofits. A popular retrofit for downflow units is replacing the fan with an underfloor, direct-drive, ECM plug fan.

Measuring Actual Operating Efficiency

- A data center owner with an interest in energy efficiency will want to know how the actual operating efficiency of his CRACs compare to the manufacturer's rating. The difference can be significant, depending on how far the real-world operating conditions vary from the standard test conditions. Refer to the Metering & Monitoring section below.

Air Handlers

- CRACs are the most common form of cooling system in small and medium sized data centers, but they are not the only solution, nor are they generally the most efficient solution.
- Air handlers served by a chilled-water system are another solution for data center cooling. The term "air handler (AH)" covers purpose-built Computer Room Air Handlers (CRAHs) and generic AH units. The latter can easily be adapted to data center use. In addition to offering better overall system efficiency, central air handlers can incorporate air-side economizers. Refer to the Economizer section below.
- Air handlers should be provided with variable speed fans.
- ECBC 2017 does not specify performance criteria for air handlers or for an entire chilled-water cooling system (chiller plant plus air handlers). Nonetheless, if the designer of a chilled-water cooling system follows the criteria for the components as described in the following sections, the result will be an efficient system.

Pumped Refrigerant System

- A pumped refrigerant system is a form of economizer (see Economizer section) that provides free cooling through automatic controls.
- During economization, the compressor is off, and the pump circulates refrigerant to the indoor coil for space cooling.

Other Solutions

- The closer the cooling coil can be placed relative to the heat source (the IT hardware), generally the more efficient the cooling system can be. Figure 6 shows comparative tests of various data center cooling technologies.

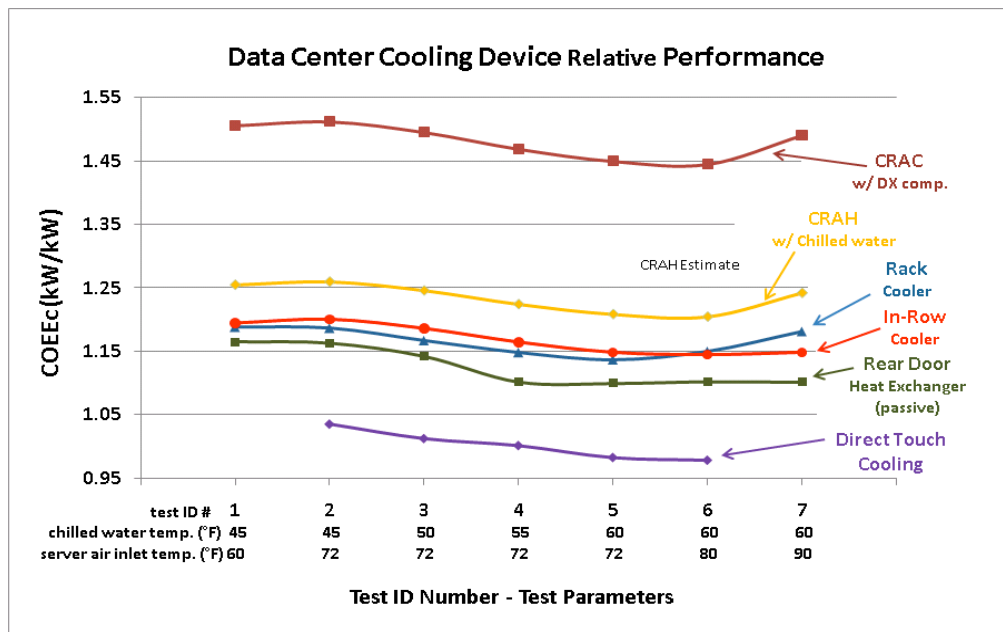

Figure 6. Tested efficiency of data center cooling options (Source: LBNL Study)

- In-row air handlers have a similar form factor as IT hardware racks and are designed to be placed between racks in a row. Typically, in-row cooling is combined with good hot aisle containment and offers an efficient package.
- Rear door heat exchangers (RDHX) are cooling coils that attach to the back of the server racks. RDHX can be “passive” relying on the server fans to push warm air through the coil, or “active” that include auxiliary fans in the door to move the air.
- “Liquid cooling” can dispense with air flow entirely. For example, cooling fluid can be brought into direct contact with the server CPUs or the server components can be immersed in a non-conducting fluid. Direct-touch liquid cooling significantly increases the potential data center equipment (heat) density and can operate at warm temperatures, eliminating the need for compressor-based cooling in some cases.
- Through heat recovery, heat removed from a data center can be directed to nearby uses rather than simply rejected it to the environment. The NREL report in the Additional Resources section at the end of this guide provides an example.

Resources

Variable-Speed Fan Retrofits for Computer-Room Air Conditioners. Report, 2013. Steve Greenberg, Lawrence Berkeley National Laboratory. This case study documents three retrofits to existing constant-speed fans in computer-room air conditioners (CRACs), all located in California: first, a 40-year-old, 6,000 sq. ft. data center located at the Lawrence Berkeley National Laboratory (LBNL) in Berkeley, with down-flow, water-cooled CRACs; second, a three-year-old, 1,000 sq. ft. data center owned by NetApp in Sunnyvale, with up-flow, water-cooled units; and, third, a 12-year-old, 1,300 sq. ft. data center owned by the Electric Power Research Institute (EPRI) in Palo Alto, with down-flow, air-cooled units. [Link](#).

AHRI Standard 1361 (SI), 2017 Standard for Performance Rating of Computer and Data Processing Room Air Conditioners. [Link](#).

ASHRAE Standard 127-2012 Method of Testing for Rating Computer and Data Processing Room Unitary Air Conditioners. [Link](#).

Pumped Refrigerant Economizers for Use in Computer Rooms. Report, 2015. Mark Alatorre, California Energy Commission CEC-400-2015-029. California’s Building Energy Efficiency Standards require the mechanical cooling equipment serving a computer room to

be equipped with either an integrated air-side economizer or an integrated water-side economizer. Pumped refrigerant economizing uses a similar concept for energy savings, in that it bypasses the compressor for mechanical cooling by using a pump to move the refrigerant through the evaporator and condenser. Available as Exhibit B in a CEC filing: [Link](#).

Liquid Cooling. Reports, 2010-2020. Center of Expertise for Energy Efficiency in Data Centers. This website provides links to reports that address the subject of liquid cooling in data centers. [Link](#).



While ECBC 2017 did not formally adopt air management related standards for data centers, most data centers have significant opportunities for improvement in air management. The following recommended requirements apply to a data centers designed for 100 kW or more.

Level I	Level II	Level III
<p><u>ECBC Compliant</u></p> <p>ECBC 2017 does not address Air Management.</p> <p><u>Recommended Additional Requirements</u></p> <ul style="list-style-type: none"> ✓ Provide good air management (reduce bypass and recirculation) such that there is no more than 50% extra supply air relative to IT airflow 	<p><u>ECBC+</u></p> <p><u>Recommended Additional Requirements</u></p> <ul style="list-style-type: none"> ✓ Hot or cold aisles containment ✓ Include air barriers such that there is no significant air path for hot IT discharge air to recirculate back to the IT inlets without passing through a cooling system. ✓ IT inlet temperature shall be no more than 3.6°C higher than the cooling system supply air temperature. ✓ No more than 30% extra supply air relative to IT airflow. 	<p><u>SuperECBC</u></p> <p><u>Recommended Additional Requirements</u></p> <ul style="list-style-type: none"> ✓ IT inlet temperature shall be no more than 1.8 °C higher than the cooling system supply air temperature. ✓ No more than 15% extra supply air relative to IT airflow ✓ Automatic variable airflow control.

Tips and Best Practices

General

Heat must be removed from the IT equipment (e.g., servers) effectively and efficiently to keep the server cool and to enhance performance of the server. Figure 7 shows the way that cool air enters a server and that its fan discharges hot air. The server fan energy is dependent on the fan speed, and the fan speed varies depending on inlet air temperature and the IT processing load. The inlet temperature depends on several factors including air distribution, supply-air temperature and mixing of hot and cold air.

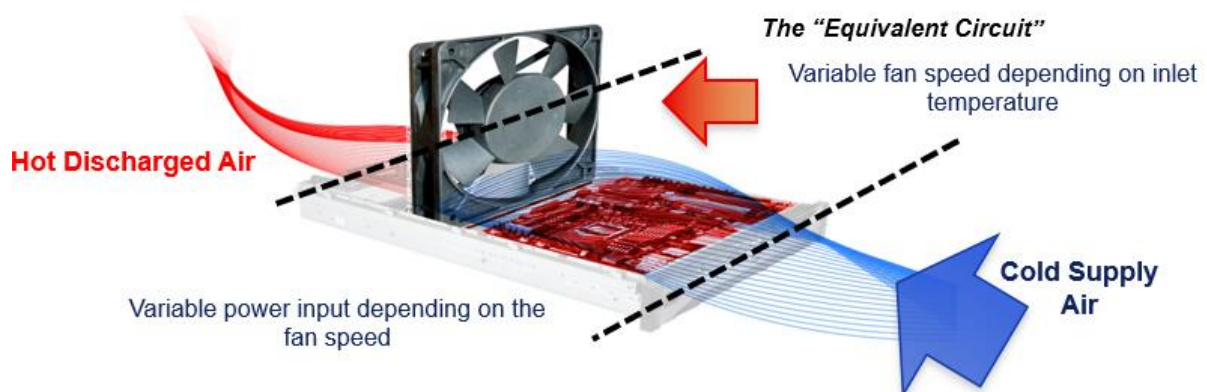

Figure 7. Air management within a server, showing supply of cool air and discharge of hot air (Source: Vertiv)

The intent of air management is to deliver cooling air directly to the IT hardware, then return the warmed air directly to the cooling coils with as little bypass and/or recirculation as possible.

Figure 8 illustrates typical airflow in a hot and cold aisle configuration. While hot and cold aisles are a first step to good air management, they do not prevent bypass (excess cold air including leaks) and recirculation (hot air discharged from the IT equipment re-entering IT equipment without being cooled). Air management also requires control of the airflow to minimize excess, see CRAC and Fan System sections for variable fan speed control requirements. Air management saves energy by optimizing airflow.

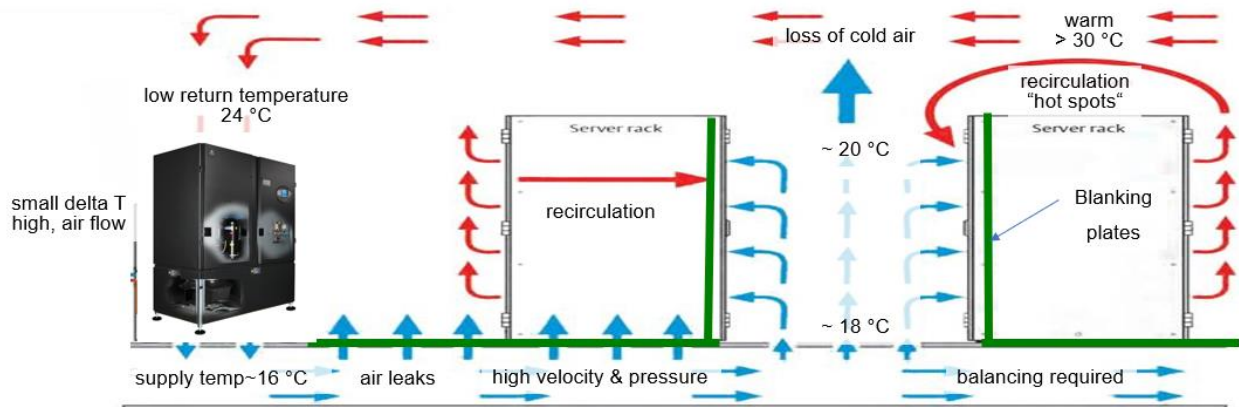

Figure 8. Typical airflow in hot and cold aisles (Source: Vertiv)

Better air management can be achieved by containing the supply air, the return air, or both. In data centers with such containment systems, the direction of air flow (top or bottom discharge) in the CRAC or air handler is of little concern.

Level I performance should be attainable with the following air management measures:

- Server racks and perforated floor tiles arranged to create hot & cold aisles.
- No gaps between or under the server racks or around cables.
- Blanking plates placed in empty server slots in each rack.

Level II performance should be attainable with the addition of:

- Cold or hot aisle containment including doors on the ends of the aisles, air baffles or dams above the aisles (on top of the racks), and a ceiling plenum return.
- Variable speed CRAC/CRAH fan controls.

Level III performance should be attainable with the addition of:

- Full containment. Example: Fully enclosed hot aisles with plenum or ducted return.
- Variable air volume (VAV) control.
- Greater attention to installation and operational details.

Attention to details and continuous commissioning is essential to maintain good air management. For example, when a server is removed it should be replaced with a blanking panel. To meet the performance specifications above (e.g. limited excess airflow and mixing) requires good design (e.g. aisle containment and VAV) but equally important, conscientious operation including the procurement of IT equipment with front to back airflow (refer to the IT hardware section).

Air management

Saving energy with air management is a two-step process:

1. Physically arrange the space to promote separation of hot and cold air. This can be accomplished by several measures per above. These measures by themselves do not save energy but rather enable savings.

- To realize the savings, at least one of two additional things must happen: increase the supply air temperature (higher cooling efficiency and economizer utilization) and/or decrease the supply airflow rate (lower fan operating costs and increased delta T).

Air Management with Containment

- Optimal performance of aisle containment requires pressure control. The diagrams below (Figure 9) illustrate pressure differences in the cold and hot aisles. Pressurized cold aisles do not allow backflow of hot air. However, too much pressure in cold aisles may result in leakages and inefficiency. Hence, it is essential to provide controls that maintain optimum pressure in the aisles.

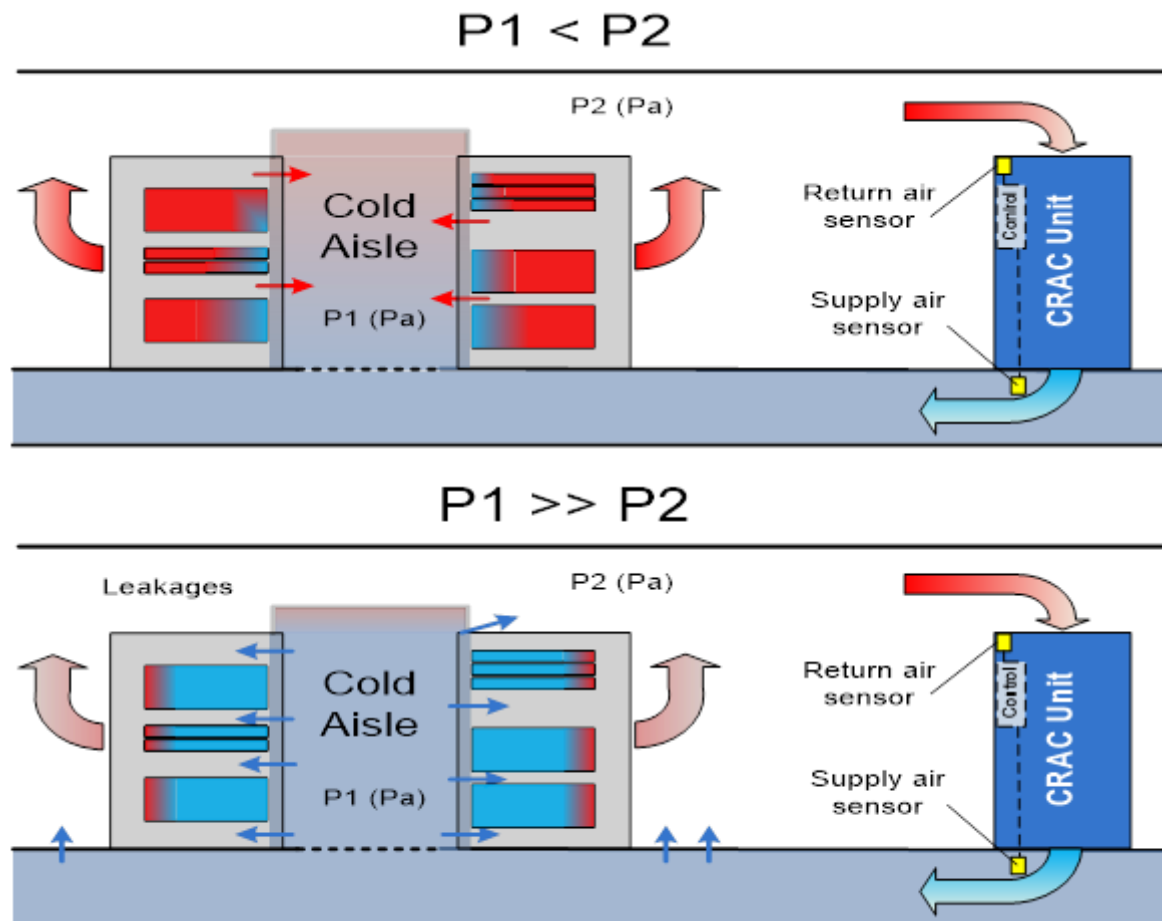

Figure 9. Illustrations of under and over pressure in a cold aisle (Source: Vertiv)

- Airflow is typically controlled by variable speed fans and is sometimes augmented with duct or in-floor dampers if there is a large variation from row to row or even within a row.
- Airflow and air pressure in the contained aisles can be controlled based on temperature or pressure:
 - Using the IT equipment air intake temperature (typically at the top of the rack) is a good scheme to control airflow. The intake temperatures are compared to the temperature standard chosen for the data center (e.g., ASHRAE recommended and allowable temperatures) and the airflow is increased as the temperature rises. The IT equipment air intake temperature (typically at the bottom of the rack) is used to control the supply-air temperature.
 - By controlling the cooling system (supply airflow and supply temperature) based on the IT air intake temperatures, optimal performance can be achieved. As described above, the CRAC or CRAH cooling coil temperature can be

controlled based on the inlet at the bottom of the rack with the setpoint a bit below the high end of the recommended temperature range. While the fan speed of the CRACs or CRAHs would be controlled based on the IT inlet temperatures towards the top of the rack.

- The airflow can also be controlled on the underfloor pressure and/or the difference in pressure between the contained aisle and room.
- The selected under-floor pressure needs to be well-coordinated with the number, location, and opening of the perforated floor tiles to balance supply airflow with IT requirements.
- Pressure control systems can be challenging given the wide variation in conditions, both under the floors and in the aisles. In a fully enclosed aisle configuration, it is possible to control CRAC or CRAH fan speed based on differential pressure between the cold aisle and the hot aisle, with the cold aisle pressure being slightly positive relative to the hot aisle.
- Data centers can use a combination of pressure and temperature sensors to control and optimize the supply air temperature and flow.
- Sometimes temperature measurement at the top of cold aisle containment provides misleading feedback to the CRAC/CRAH. For example, if blanking panels are missing in the mid-section, the top sensor may provide a low temperature input to CRAC/CRAH, while IT hardware mounted in the center of IT racks may suffer high temperatures due to shortfall of cold air and recirculation of hot air from back to front occurring at the center of the rack.
- Strategic placement of differential pressure sensors (see P1 and P2 in Figure 10) provides the best feedback to the CRAC/CRAH. Cold aisle pressure (P1) can be kept higher while restricting the airflow <15% from what is required by IT hardware. This monitoring method also highlights the integrity of cold aisle containment.
- Commonly, differential pressure sensors are kept under the raised floor plenum and CRAC/CRAH return air path. Volume control dampers in front of racks can be used for airflow balancing and management. Any change in the IT load results in a change in the demand of cold air leading to changes in differential pressure feedback to the CRAC/CRAH, which compensates for airflow demand.

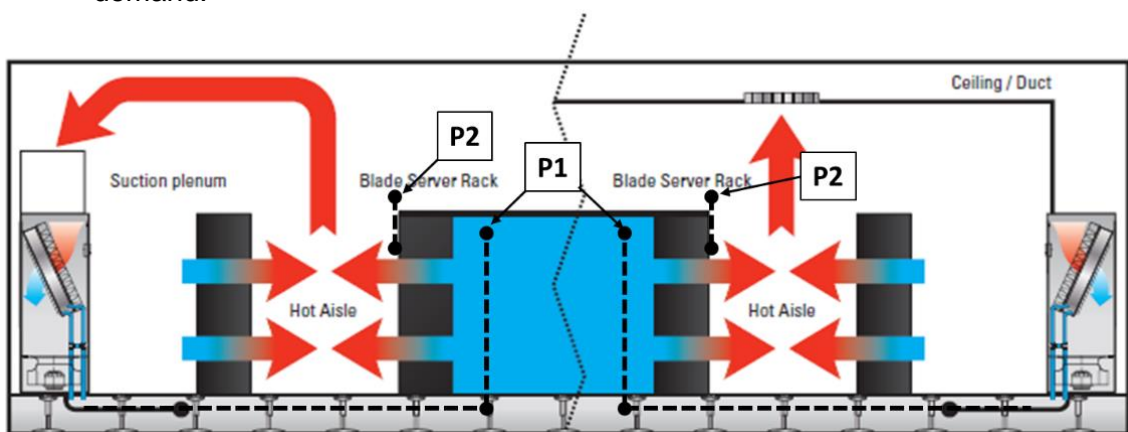

Figure 10. Illustration of pressure sensor locations (Source: Schneider Electric)

- There is a growing trend towards hot aisle containment with cold (or actually warm) air “flooding” the rest of the data center. Instead of an underfloor air supply, the entire data center acts as a cold air plenum under a higher pressure than the enclosed hot aisles.

Representation of air distribution in server hall for Level III.

- With good containment, pressure and airflow control, as well as conscientious operation, air management can be optimized resulting in high energy efficiency, as shown in Figure 11.

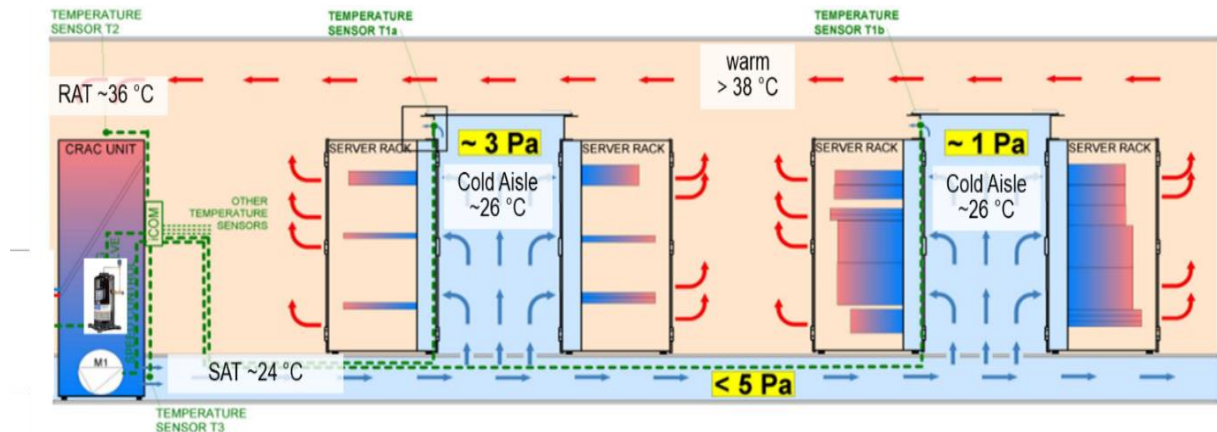

Figure 11. Illustration of an air management scheme in a Level III data center (Source: Vertiv)

Other Solutions

- **Liquid cooling.** “Liquid cooling” can dispense with all or most of the required airflow. Liquid cooling can be made “room neutral” meaning that all the heat is removed at the chip, rack, or row level, and no heat goes into the data center room. Essentially, the load is not visible to the normal cooling units. Refer to CRAC section above for additional information and resources on liquid cooling.
- **Supply fan speed control.** Fan speed control can assist air management including pressure control. Supply fan speed control is necessary in modern data center environments since the IT fans are VAV. Refer to the Fans Systems section below.

Resources

The Air Management Tool. Software tool, 2014. Lawrence Berkeley National Laboratory. The Air Management Tool was developed to accelerate energy savings in data centers without affecting the thermal IT equipment environment by assessing the data center air-management status. Based on user input, the tool provides air management recommendations and the potential for reducing the supply airflow rate and increasing the supply air temperature without affecting the thermal equipment environment. [Link](#).

The Air Management Estimator. Software tool, 2017. Lawrence Berkeley National Laboratory, ANCIS. The Air Management Estimator is a simplified version of the Air Management Tool that uses the same engine. The input options in this tool have been reduced in favor of increased clarity. [Link](#).

Demonstration: Portable Air Management Measurement Tools. Report, 2018. Magnus Herrlin, Steve Greenberg, Lawrence Berkeley National Laboratory. This demonstration involves two inexpensive, portable measurement tools for assessing air management in small data centers (<5,000ft² or <464m²) on a limited, temporary basis. Access to simple, inexpensive tools for implementing and tracking air management is imperative in such environments. Besides evaluating the accuracy of the temperature measurements, this report also includes an evaluation of the ease of use of the tools. [Link](#).

Air Management in Small Data Centers. Report, 2016. Magnus Herrlin, Lawrence Berkeley National Laboratory. Randall Cole, Pacific Gas & Electric Company. This report focuses on improving air management in small data centers due to the great potential for collective energy savings. To implement air management, key environmental parameters need to be monitored. Both complex and simple tools are described. Due to many challenges in identifying and implementing efficiency measures in small data centers, it would help to provide utility incentives for rapidly deployable “packages” of air management measures that require only marginal customization. Such packages were developed based on computer modelling. The report also outlines the process to select the packages, calculate the energy savings, determine the cost of the packages and establish the rebates. [Link](#).

Air Management Webinar. Slides, 2018. Magnus Herrlin, Lawrence Berkeley National Laboratory. From Magnus Herrlin’s April 12, 2018 Federal Energy Management Program (FEMP) presentation on air management. The presentation covers basic air management “best practices” and detection and correction of common problems. The importance and key goals and results with air management are reviewed in some detail. [Link](#).

Temperature & Humidity Control



ECBC 2017 includes energy efficiency requirements for temperature and humidity control. Mechanical heating and cooling equipment in all buildings shall be installed with controls to manage the temperature inside the conditioned zones.

Level I	Level II	Level III
<p><u>ECBC Compliant</u></p> <p>ECBC 2017 Section 5.2.3.2: Temperature Controls</p> <ul style="list-style-type: none"> ✓ Each floor or building block shall be installed with at least one control to manage the temperature. ✓ Separate thermostat control shall be in each computer room. 	<p><u>ECBC+</u></p> <p>ECBC 2017, Sections 5.3.9.1: Centralized Demand Shed Controls; Section 5.3.9.2: Supply Air Temperature Reset; Section 5.3.9.3: Chilled Water Temperature Reset</p> <ul style="list-style-type: none"> ✓ Centralized demand shedding controls shall have capabilities to be disabled by facility operators and be manually controlled by a central point by facility operators to manage cooling set points. ✓ Supply air temperature reset capabilities. Controls shall reset the supply air temperature to at least 25% of the difference between the design supply air temperature and the design room air temperature. ✓ Chilled-water systems with a design capacity >350 kW_r supplying chilled water to comfort conditioning systems shall have controls that automatically reset supply water temperatures by representative building loads (including return water temperature) or by outdoor air temperature. ✓ Exceptions: Controls to automatically reset chilled water temperature shall not be required where the supply temperature reset controls causes improper operation of equipment. <p><u>Recommended Additional Requirements</u></p> <ul style="list-style-type: none"> ✓ CRACs/air handlers shall operate on supply air temperature control instead of return air temperature control. ✓ CRACs/air handlers shall have the ability to provide inlet supply air at the upper limit of the ASHRAE recommended temperature/humidity range. This means systems support high supply air temperature (26/27°C) and return air temperature (38/40°C). 	<p><u>SuperECBC</u></p> <p><u>Recommended Additional Requirements</u></p> <ul style="list-style-type: none"> ✓ Air handlers shall have the ability to control inlet supply air dewpoint temperature or inlet supply air relative humidity, to conform with the ASHRAE recommended range. ✓ All air handler operating modes (supply air temperature & humidity setpoints, actual supply air temperature and humidity, de-humidification status, reheat status) shall be monitored from a central monitoring system. Refer to the Metering and Monitoring section below. ✓ Units shall operate on IT rack intake temperature control instead of supply or return air temperature control.

	<ul style="list-style-type: none"> ✓ Cooling system controls shall prevent simultaneous humidification & dehumidification by multiple units serving the same space. 	
--	----------------------------------------------------------------------------------------------------------------------------------------------------------------------------------------	--

Tips and Best Practices

General

- “Floor” or “building block” refers to a data center room.
- “Design room air temperature” refers to allowable IT hardware inlet air temperature & relative humidity.
- Optimizing air management results in lower fan energy and larger delta Ts. For fan speed control options, refer to the Fan Systems section below.
- Variable cooling capacity CRACs such as multi-stage or variable speed compressors are recommended. Supply air temperature tends to oscillate widely with single-stage compressors, making supply air temperature control difficult.
- CRACs are typically autonomous, each one operating with its own on-board controls. This can lead to situations where adjacent CRACs are “fighting” each other. For example, one CRAC may be humidifying, and a nearby unit is simultaneously dehumidifying. This consumes energy to no purpose. Such conflicting operations can be avoided by installing and using a centralized control system or smart controls.

Air Temperature Control

- CRAC/CRAH controls are commonly set up to maintain a constant return air temperature and a constant air flow. In this case, the supply air temperature cannot be simultaneously controlled; it will be a result of the cooling load encountered. To meet the acceptable range of IT hardware inlet temperature, it is better to control supply air temperature. This can be done at the CRAC/CRAH units or even better is to sense the temperature at the computer racks themselves.
- If a CRAC/air handler is controlling its supply air temperature and also controlling its fan speed to maintain a differential air pressure setpoint, then the return air temperature cannot also be simultaneously controlled; it will be a result of the cooling load encountered. Therefore, the return air temperature range (38/40°C) cited above (Level II Recommended Additional Requirements) is not a setpoint but rather a required operating range. With improved air management and use of the upper end of the ASHRAE recommended supply air temperature range, return air temperatures can be higher than older equipment’s rated conditions. New equipment should be specified for operation at these new higher temperature conditions, which in turn results in higher capacity and efficiency from a given CRAC unit.
- Ideally controls are set up to maintain an IT hardware inlet temperature setpoint rather than CRAC/air handler supply or return air temperature. This is the most robust way to ensure the hardware is receiving the correct air conditions, however, attention shall also be directed to proper air management. Poor air management can lead to the CRAC/air handler producing a lower supply air temperature (requiring more energy) in order to meet the IT hardware’s inlet setpoint.
- Figure 12 shows [thermal guidelines for IT equipment](#) through a psychometric chart. These conditions pertain to the air entering the IT equipment. The recommended environmental envelope provides guidance on where facilities should be designed and operated to provide long-term reliability and energy efficiency of the IT equipment. The allowable envelopes (A1 – A4) are where IT manufacturers test their equipment in order to verify that it will function but ultimately are meant for short-term operation. The allowable classes may enable facilities in many geographical locations to operate all

or much of the year without the use of compressor-based cooling, which can provide significant savings in capital and operating expenses in the form of energy use.

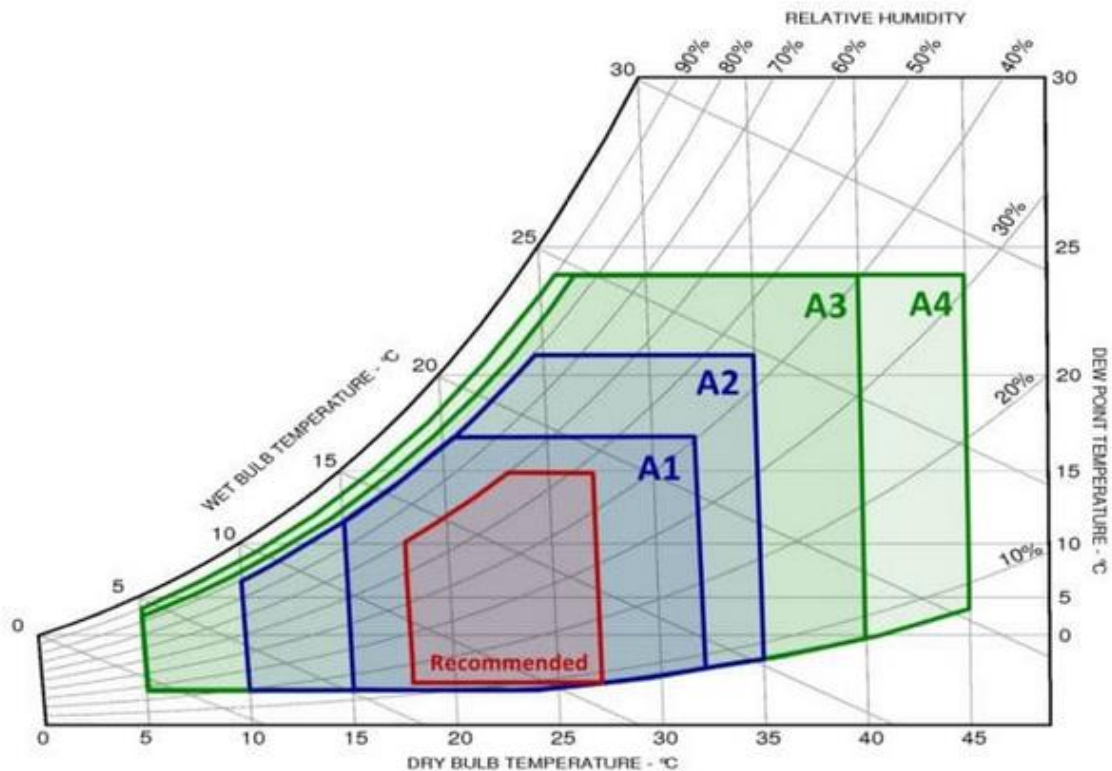

Figure 12. ASHRAE thermal guidelines for data centers (2015 & 2016 errata)

ASHRAE’s thermal guidelines were established by consensus among the major manufacturers of IT equipment. The temperatures and humidity’s in the various ranges refer to the conditions at the air inlet of the IT equipment. The recommended range is a statement of reliability; for extended periods of time, manufacturers recommend that data centers maintain their environment within these boundaries. The recommended range is used for design operating conditions for the large majority of hours of the year. The allowable ranges are statements of functionality; these are the boundaries where IT manufacturers test their equipment to verify that the equipment will function. These allowable ranges are used for design operating conditions during a small minority of hours of the year, for example, enabling more hours of water or air-side economizers or ensuring the data center will operate when the outside temperature or humidity are beyond the design conditions when recommended thermal conditions can be met. Operating IT equipment continuously in the allowable range could result in reduced equipment lifetime. Operating IT equipment outside of its allowable range risks equipment failure.

Note that because these ranges were selected by consensus, they are conservative “lowest common denominator” standards, and the recommended ranges for specific IT equipment are typically less strict.

Refer to IT Hardware section below for additional guidance on specifying ASHRAE Class A 1-4 IT equipment.

Resources

Data Center Efficiency & IT Equipment Reliability at Wider Operating Temperature and Humidity Ranges. Report, 2012. Steve Strutt, Chris Kelley, Harkeeret Singh, Vic Smith, Green Grid. Many data centers can realize overall operational cost savings by leveraging a wider range of temperature and humidity limits as established by equipment manufacturers. [Link](#).

2015 Thermal Guidelines for Data Processing Environments, 4th Edition. Guide, 2015. ASHRAE Technical Committee 9.9.

IT equipment environmental requirements are often mismatched with adjacent equipment requirements or with facility operating conditions. The ASHRAE Thermal Guidelines for Data Processing Environments provides a framework for improved alignment of efforts among IT equipment hardware manufacturers (including manufacturers of computers, servers, and storage products), HVAC equipment manufacturers, data center designers and facility operators and managers. This guide covers five primary areas:

1. Equipment operating environment guidelines for air-cooled equipment
2. Environmental guidelines for liquid-cooled equipment
3. Facility temperature and humidity measurement
4. Equipment placement and airflow patterns
5. Equipment manufacturers' heat load and airflow requirement reporting

This fourth edition of the guidelines features updated information as well as new discussions on topics such as increasing energy efficiency by allowing reduced moisture levels with minimum risk of electrostatic discharge. The guide provides vendor-neutral information that will empower data center designers, operators and managers to better determine the impact of varying design and operation parameters. [Link](#).

2016 Errata to Thermal Guidelines for Data Processing Environments, 4th Edition. Guide, 2016. ASHRAE Technical Committee 9.9. [Link](#).

Humidity Control in Data Centers. Report, 2017. Vali Sorell, Syska Hennessey. Magnus Herllin, Lawrence Berkeley National Laboratory. This report reviews the evolution of humidity control in data centers and makes recommendations on how to meet the current humidity control requirements in an energy-efficient manner. Guidance on the use of evaporative cooling is also provided. [Link](#).



ECBC 2017 provides requirements for fan mechanical efficiency and fan motor efficiency at the ECBC Compliant, ECBC+ and SuperECBC levels. These efficiencies are only one aspect of fan systems; other considerations are addressed in the Tips section below.

Level I	Level II	Level III
<p><u>ECBC Compliant</u> ECBC 2017 Section 5.3: Prescriptive Requirements</p> <ul style="list-style-type: none"> ✓ Supply, exhaust, and return or relief fans with motor power exceeding 0.37 kW shall meet or exceed: <ul style="list-style-type: none"> • Fan mechanical efficiency of 60%. • Motor efficiency IE2, as per IS 12615. <p>Exception:</p> <ul style="list-style-type: none"> ✓ Fans in un-ducted air conditioning unit where fan efficiency has already been taken in account to calculate the efficiency standard of the unit. 	<p><u>ECBC+</u></p> <ul style="list-style-type: none"> ✓ Fan mechanical efficiency of 65%. ✓ Motor efficiency IE3, as per IS 12615. <p><u>Recommended Additional Requirements</u></p> <ul style="list-style-type: none"> ✓ Provide variable speed controls on all fans including CRAHs, and AHUs (variable speed fan control on CRAC units is required at Level I – see CRAC section). 	<p><u>SuperECBC</u></p> <ul style="list-style-type: none"> ✓ Fan mechanical efficiency of 70%. ✓ Motor efficiency IE4, as per IS 12615.

Tips and Best Practices

Fan Power

An electric fan system consists of a variable speed controller (optional), the motor, the transmission (belt, gearbox, or direct drive) and the fan. The power demand of the fan system depends on the amount of air it is moving, the resistance to the airflow and the efficiency of each system component.

Air Flow Rate

If the air flow rate can be reduced, fan energy will be saved. To reduce the airflow and still successfully handle the cooling load, the temperature difference between the supply and return air (the “delta-T”) must increase.

Pressure Drop

The power required by a fan increases with the resistance (the “pressure drop”) experienced by its airflow, and the pressure drop tends to increase exponentially with the airflow rate. Significant energy savings are realized by minimizing resistance to flow throughout the airflow loop. Considerations include:

- **Air filters and coils.** Select low pressure drop filters and coils (typically larger face area).

- **Raised floor height.** A minimum of 600mm clear height is recommended, but optimum height is dependent on the design cooling load.
- **Passive systems.** Oversizing passive systems such as ducts, coils, filters, and plenum spaces including raised floor and dropped ceilings adds future flexibility and reduces pressure drop.
- **Floor Tiles.** Avoid overly restrictive perforated floor tiles. This can be caused by not enough perforated tiles or perforations that are too small. But too large of openings can make flow balancing difficult and lead to excessive flow. Make sure perforated tiles are only placed in the cold aisles.
- **Pressure setpoint.** CRACs and air handlers with variable speed fans can be controlled to maintain a constant pressure setpoint in the underfloor space. The setpoint needs to be high enough to successfully deliver cooling air to the IT hardware, but setting it too high wastes energy. To allow for variable air volume (responding to IT load), fan speed can alternatively be controlled by IT inlet temperature (typically at the top of the rack).
- **Ducts.** Ducts with a large cross-sections and gentle bends offer less flow resistance.
- **Air balancing.** If the air distribution system has multiple branches, it may have balancing dampers installed. During commissioning, make sure that at least one of the dampers is wide open.

Component Efficiency

The greater the efficiency of each fan system component, the less power is required.

- **Fan Motor.** Required fan motor efficiencies are specified in the table above. Electrically Commutated Motors (ECMs) currently provide the highest efficiency capability.
- **Variable Speed.** Variable speed control can add significant savings. ECMs inherently provide variable-speed capability.
- **Transmission.** A direct drive (motor shaft bolted directly to the fan shaft) is 100% efficient. Belt drives and gearboxes are less efficient.
- **Fan.** Required fan efficiencies are specified in the table above. Plug fans (also known as plenum fans) discharge air into a plenum rather than a duct. They are direct-drive and often provide a more efficient solution.
- **Fan System.** Many highly efficient data center fan systems utilize EC motors directly driven plug fans with horizontal underfloor air distribution. A motorized impeller is an integrated fan and motor assembly that typically uses an ECM and a plug fan.

Fan Speed Control

ECBC 2017 adopted energy efficiency requirements for fan control at the SuperECBC level only. The requirements apply to CRACs/air handlers with a mechanical cooling capacity exceeding 18 kW_r. Fan speed control should be considered for all data center applications and offers possible energy savings in two ways:

1. The fan is set to a fixed speed that yields the desired constant air flow rate, without needing to choke the air flow path to fight against full fan speed. Systems that control to a constant differential pressure setpoint fit this description.
2. An automatic control scheme varies the airflow depending on the thermal load. This minimizes fan energy and maximizes cooling system performance.

While speed control enables efficient operation, optimum efficiency also requires that the air flow path is not overly restrictive, that no more air is being moved than is necessary, and that the fan system components are efficient.

Electrically Commutated Motors (ECMs)

ECMs offer more energy savings as compared to standard motors equipped with VFD controls. Figure 13 shows the comparison between an ECM motor and an alternating current induction motor (ACIM) with a VFD control. Refer also to CRAC Efficiency section.

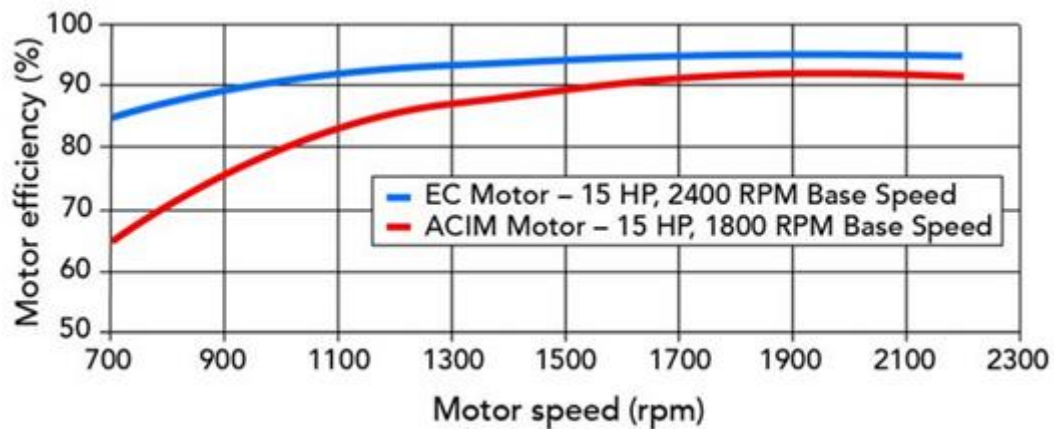

Figure 13. Comparison of fan power in electrically commutated motor (ECMs) and VFD controlled ACIM systems (Source: NovaTorque, [Link](#))

Resources

Air Movement & Control Association, Asia. AMCA International. Mission: "To promote the Health and Growth of the Industries covered by its Scope and the Members of the Association consistent with the interests of the Public." [Link](#).

Demonstration of Intelligent Control and Fan Improvements in Computer Room Air Handlers. Report, 2012. Henry Coles, Steve Greenberg, Lawrence Berkeley National Laboratory; Corinne Vita, Vigilant. Computer room air handlers (CRAHs) at a Digital Realty Trust data center were retrofitted with improved efficiency fans and controlled by a central control system provided by Vigilant. The resulting efficiency improvements were analyzed in this report. [Link](#).



The ECBC 2017 requirements for economizers apply to buildings with a built-up area greater than 20,000 square meters. We take the economizer requirement to apply to data centers with a total load capacity of more than 100kW. Economizers dissipate heat to the outdoor air without using compressors and include direct and indirect air economizers, water-side economizers tied to cooling towers or dry coolers, and pumped refrigerant.

Level I	Level II	Level III
<p><u>ECBC Compliant</u></p> <p>ECBC 2017 Section 5.3.6.1: Economizers</p> <p>Each cooling system shall include at least one of the following:</p> <ol style="list-style-type: none"> 1. An air economizer capable of modulating outside-air and return-air dampers to supply outside air for 50% of the design supply air quantity. 2. A water economizer capable of providing 50% of the expected system cooling load at outside air temperatures of 10°C dry-bulb/7.2°C wet-bulb and below. <ul style="list-style-type: none"> ✓ Economizers shall be capable of providing partial cooling even when additional mechanical cooling is required to meet the cooling load. ✓ Economizer controls and testing are delineated. <p>Exceptions:</p> <ul style="list-style-type: none"> ✓ Projects in warm-humid climate zones are exempt. ✓ Projects with only daytime occupancy are exempt. ✓ Systems less than 3,200 liters per second are exempt. <p><u>Recommended Additional Requirements</u></p> <ul style="list-style-type: none"> ✓ Use of economizer for ECBC compliance is waived off for data centers below 100 kW load. ✓ The exception for daytime occupancy is removed, as the data center is assumed to be continuously operated (24/7) even if not occupied. ✓ Economizer systems (all types) shall be capable of providing at least 50% of the cooling load at outside temperatures of <7.2°C wet-bulb. 	<p><u>ECBC+</u></p> <p><u>Recommended Additional Requirements</u></p> <ul style="list-style-type: none"> ✓ Economizers shall be capable of providing 100% of the expected system cooling load at outside air temperatures <7.2°C wet-bulb. <p>Exceptions:</p> <ul style="list-style-type: none"> ✓ None. 	<p><u>SuperECBC</u></p> <p><u>Recommended Additional Requirements</u></p> <ul style="list-style-type: none"> ✓ Economizers shall be capable of providing 100% of the expected system cooling load at outside air temperatures <12°C wet-bulb.

Tips and Best Practices

- Economizers are often run in a combination mode with compressor-based cooling. Outside air is used to partially cool or precool the air or water, while the compressor-based cooling provides the remaining requirements.
- Air-side economizers have successfully been used in India. For example, the NetApp data center in Bangalore uses such a system (see case study below under Resources).
- Air quality and filtration: An air quality test should be performed on site prior to constructing a data center. If gaseous contaminants are present, the location of the data center should be reconsidered. Otherwise, enhanced filtration will be required even if outside air is not used for cooling. Particulate contamination can be addressed with standard filtration (see study under Resources).
- Higher return air temperatures made possible by improved air management can greatly increase the number of economizer hours.
- Operating data centers at higher ASHRAE-recommended supply air temperatures allow for significantly warmer supply air, which increases the number of hours the economizer can operate.
- Optimum chilled-water temperatures should be evaluated for CRAHs and chillers to achieve the highest possible efficiency for the given ambient conditions. For example, operating chillers at a water outlet temperature of 22°C with inlet temperature of 30°C provides high efficiency without compromising rack air inlet temperature. Increased chilled-water temperatures that are enabled by higher supply and return air temperatures, can greatly increase the number of economizer hours.
- Many data center designers and operators are more comfortable with economizers that do not introduce outside air into the data center for cooling. Options include air-to-air heat exchangers, “tower side” economizers (that utilize water cooled by the cooling towers) or pumped refrigerant economizers.
- CRAC units can be designed with a pumped refrigerant economizer or a dual coil to utilize a water-side economizer (e.g., cooling tower). During economization in a pumped refrigerant system, the compressor is off, and the pump circulates refrigerant to the indoor coil for space cooling. Figure 14 illustrates the two modes of operations for a pumped refrigerant economizer system.

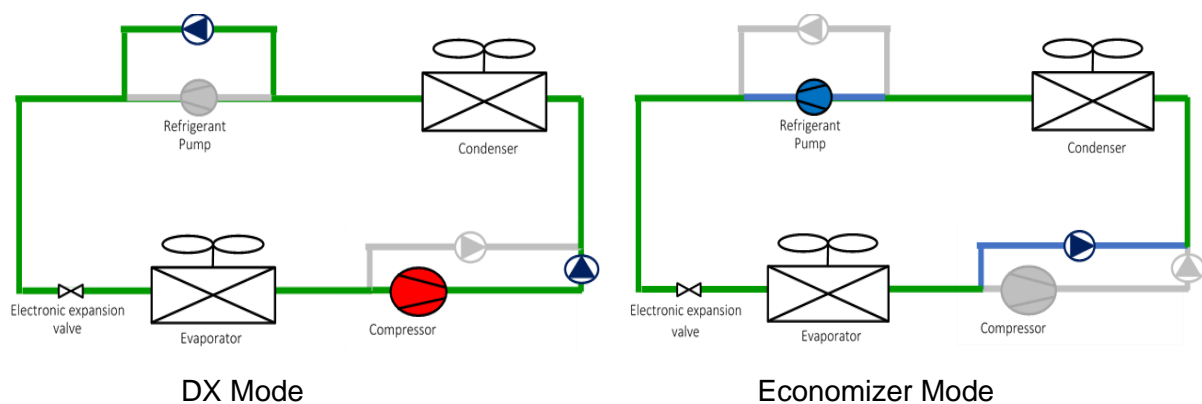

Figure 14 Pumped refrigerant economizer modes.

- Water-side economizers can utilize cooling towers to take advantage of lower wet bulb temperatures or can utilize adiabatic (see cooling tower section) or fully dry coolers, with the latter illustrated in Figure 15.

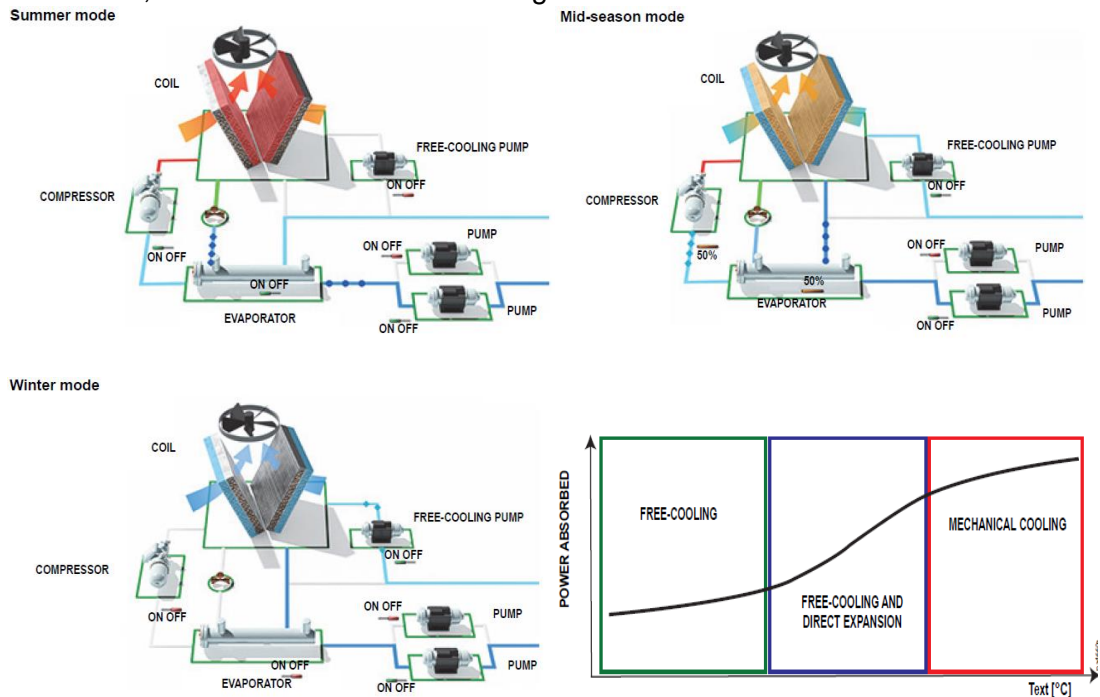

Figure 15 Water-side economizer in summer, mid-season, and winter modes (Mechanical cooling, free cooling and direct expansion, and free cooling) (Source: Schneider Electric)

Resources

NetApp Case Study. 2021. Case Study of NetApp's Bangalore data center using outside air economizer and other efficiency features. NetApp was one of the first companies in the United States to use outside air for cooling, and they have continued to do so throughout the world with their latest installation in Bangalore, India. [Link](#). Presentation: [Link](#).

Reducing Data Center Cost with an Air Economizer. Report, 2008. Don Atwood, John Miner, Intel. To challenge established industry assumptions regarding data center cooling, Intel IT conducted a proof of concept (PoC) test that used an air economizer to cool production servers with 100 percent outside air at temperatures of up to 90 °F. [Link](#).

Impact of Air Filtration on the Energy and Indoor Air Quality of Economizer-Based Data Centers in the PG&E Territory. Report, 2009. Srirupa Ganguly, Arman Shehabi, William Tschudi, Ashok Gadgil, Lawrence Berkeley National Laboratory. A significant portion of the energy in data centers is currently dedicated to provide cooling for the server equipment. Data centers must provide continuous air conditioning to address high internal heat loads (heat release from computer servers) and maintain indoor temperatures within recommended operating levels for computers. Air-side economizers, which bring in large amounts of outside air to cool internal loads when weather conditions are favorable, could save cooling energy. A major barrier to economizer implementation is the fear of increasing pollutant levels in the data center during the economizer cycle, and the fear that these pollutants could affect computer server reliability. High efficiency HVAC filters are suggested as an option to effectively reduce particulate contamination inside the data center. Further, the energy implication of using improved filters in an air-side economizer system is also discussed. Strategies to reduce this economizer implementation barrier are explored in this study. Pollutants of concern are measured in a data center enabled with economizer operation while using air filtration of varying levels of efficiency. [Link](#).

Waterside Economizing in Data Centers: Design and Control Considerations. Guide, 2009. Jeff Stein, ASHRAE. Free cooling was not common in data centers in the past for a variety of reasons including the philosophy that data center cooling should be designed for maximum reliability and not for energy efficiency. Energy and sustainability are more important to many data center owners now, and sophisticated owners and designers know that free cooling can provide a good return on investment while actually enhancing reliability, since economizers provide a backup to the chillers. Many data centers are being designed or retrofitted with airside economizers, waterside economizers, and even “wet bulb” economizers (direct evaporative coolers). This article briefly compares airside and waterside economizers, briefly compares the two types of waterside economizers (CRAC and chiller plant) and then focuses on design and control considerations for chiller plant waterside economizers serving data centers. [Link](#).

Data Center Economizer Cooling with Tower Water. Report, 2012. Henry Coles, Steve Greenberg, California Energy Commission. A prototype computer equipment rack-level cooling device with two heat exchangers was demonstrated to illustrate an energy efficient cooling capability. This unique device was designed and constructed to operate with higher-temperature cooling water, therefore it can support many more hours of free cooling compared to traditional systems that utilize chilled water. [Link](#).

3. Chiller Plant

The measure types in this section address the different components of a chilled-water plant.

Chillers



Of all the components in a chilled-water plant, the chillers typically draw the most power. ECBC 2017 provides chiller efficiency requirements for compliance at the ECBC, ECBC+ and SuperECBC levels.

Level I	Level II	Level III																																																						
<p>ECBC Compliant ECBC 2017 Section 5.2.2.1: Chillers</p> <ul style="list-style-type: none"> ✓ Chillers shall meet or exceed the minimum efficiency requirements under the BEE Standards and Labelling Program for chillers as and when updated by BEE. ✓ Minimum 1 star-rated chillers shall be installed. ✓ Requirements of both COP and ISEER shall be met. ✓ The application of an air-cooled chiller is allowed in all buildings with cooling load < 530 kW. ✓ For buildings with cooling load ≥ 530 kW, the capacity of air-cooled chiller(s) is restricted to 33% of the total installed chilled water capacity. ✓ BEE Schedule 21 efficiency requirements for 1 star: 	<p>ECBC+ ECBC 2017 Section 5.2.2.1: Chillers and Section 5.3.1: Chillers</p> <ul style="list-style-type: none"> ✓ Minimum BEE 3 star-rated chiller shall be installed. 	<p>SuperECBC ECBC 2017 Section 5.2.2.1: Chillers and Section 5.3.1: Chillers</p> <ul style="list-style-type: none"> ✓ Minimum BEE 5 star-rated chiller shall be installed. 																																																						
<p style="text-align: center;">Water Cooled Chillers</p> <table border="1"> <thead> <tr> <th>Chiller Capacity (kW_r)</th> <th>COP</th> <th>ISEER</th> </tr> </thead> <tbody> <tr> <td><260</td> <td>4.2</td> <td>4.8</td> </tr> <tr> <td>≥ 260 & < 530</td> <td>4.7</td> <td>5.0</td> </tr> <tr> <td>≥ 530 & < 1,050</td> <td>5.0</td> <td>5.5</td> </tr> <tr> <td>≥ 1,050 & <1,580</td> <td>5.2</td> <td>5.8</td> </tr> <tr> <td>≥ 1,580</td> <td>5.6</td> <td>6.0</td> </tr> </tbody> </table>	Chiller Capacity (kW _r)	COP	ISEER	<260	4.2	4.8	≥ 260 & < 530	4.7	5.0	≥ 530 & < 1,050	5.0	5.5	≥ 1,050 & <1,580	5.2	5.8	≥ 1,580	5.6	6.0	<p style="text-align: center;">Water Cooled Chillers</p> <table border="1"> <thead> <tr> <th>Chiller Capacity (kW_r)</th> <th>COP</th> <th>ISEER</th> </tr> </thead> <tbody> <tr> <td><260</td> <td>4.2</td> <td>5.6</td> </tr> <tr> <td>≥ 260 & < 530</td> <td>4.7</td> <td>6.2</td> </tr> <tr> <td>≥ 530 & < 1,050</td> <td>5.0</td> <td>6.7</td> </tr> <tr> <td>≥ 1,050 & <1,580</td> <td>5.2</td> <td>7.2</td> </tr> <tr> <td>≥ 1,580</td> <td>5.6</td> <td>7.4</td> </tr> </tbody> </table>	Chiller Capacity (kW _r)	COP	ISEER	<260	4.2	5.6	≥ 260 & < 530	4.7	6.2	≥ 530 & < 1,050	5.0	6.7	≥ 1,050 & <1,580	5.2	7.2	≥ 1,580	5.6	7.4	<p style="text-align: center;">Water Cooled Chillers</p> <table border="1"> <thead> <tr> <th>Chiller Capacity (kW_r)</th> <th>COP</th> <th>ISEER</th> </tr> </thead> <tbody> <tr> <td><260</td> <td>4.2</td> <td>6.6</td> </tr> <tr> <td>≥ 260 & < 530</td> <td>4.7</td> <td>7.4</td> </tr> <tr> <td>≥ 530 & < 1,050</td> <td>5.0</td> <td>8.2</td> </tr> <tr> <td>≥ 1,050 & <1,580</td> <td>5.2</td> <td>8.7</td> </tr> <tr> <td>≥ 1,580</td> <td>5.6</td> <td>9.0</td> </tr> </tbody> </table>	Chiller Capacity (kW _r)	COP	ISEER	<260	4.2	6.6	≥ 260 & < 530	4.7	7.4	≥ 530 & < 1,050	5.0	8.2	≥ 1,050 & <1,580	5.2	8.7	≥ 1,580	5.6	9.0
Chiller Capacity (kW _r)	COP	ISEER																																																						
<260	4.2	4.8																																																						
≥ 260 & < 530	4.7	5.0																																																						
≥ 530 & < 1,050	5.0	5.5																																																						
≥ 1,050 & <1,580	5.2	5.8																																																						
≥ 1,580	5.6	6.0																																																						
Chiller Capacity (kW _r)	COP	ISEER																																																						
<260	4.2	5.6																																																						
≥ 260 & < 530	4.7	6.2																																																						
≥ 530 & < 1,050	5.0	6.7																																																						
≥ 1,050 & <1,580	5.2	7.2																																																						
≥ 1,580	5.6	7.4																																																						
Chiller Capacity (kW _r)	COP	ISEER																																																						
<260	4.2	6.6																																																						
≥ 260 & < 530	4.7	7.4																																																						
≥ 530 & < 1,050	5.0	8.2																																																						
≥ 1,050 & <1,580	5.2	8.7																																																						
≥ 1,580	5.6	9.0																																																						
<p style="text-align: center;">Air Cooled Chillers</p> <table border="1"> <thead> <tr> <th>Chiller Capacity (kW_r)</th> <th>COP</th> <th>ISEER</th> </tr> </thead> <tbody> <tr> <td><260</td> <td>2.4</td> <td>3.0</td> </tr> <tr> <td>≥ 260</td> <td>2.6</td> <td>3.1</td> </tr> </tbody> </table>	Chiller Capacity (kW _r)	COP	ISEER	<260	2.4	3.0	≥ 260	2.6	3.1	<p style="text-align: center;">Air Cooled Chillers</p> <table border="1"> <thead> <tr> <th>Chiller Capacity (kW_r)</th> <th>COP</th> <th>ISEER</th> </tr> </thead> <tbody> <tr> <td><260</td> <td>2.4</td> <td>3.6</td> </tr> <tr> <td>≥ 260</td> <td>2.6</td> <td>3.9</td> </tr> </tbody> </table>	Chiller Capacity (kW _r)	COP	ISEER	<260	2.4	3.6	≥ 260	2.6	3.9	<p style="text-align: center;">Air Cooled Chillers</p> <table border="1"> <thead> <tr> <th>Chiller Capacity (kW_r)</th> <th>COP</th> <th>ISEER</th> </tr> </thead> <tbody> <tr> <td><260</td> <td>2.4</td> <td>4.4</td> </tr> <tr> <td>≥ 260</td> <td>2.6</td> <td>4.7</td> </tr> </tbody> </table>	Chiller Capacity (kW _r)	COP	ISEER	<260	2.4	4.4	≥ 260	2.6	4.7																											
Chiller Capacity (kW _r)	COP	ISEER																																																						
<260	2.4	3.0																																																						
≥ 260	2.6	3.1																																																						
Chiller Capacity (kW _r)	COP	ISEER																																																						
<260	2.4	3.6																																																						
≥ 260	2.6	3.9																																																						
Chiller Capacity (kW _r)	COP	ISEER																																																						
<260	2.4	4.4																																																						
≥ 260	2.6	4.7																																																						

<u>Recommended Additional Requirements</u>	<u>Recommended Additional Requirements</u>	<u>Recommended Additional Requirements</u>																																																																																																												
<p>✓ Requirements of both COP and ISEER shall be met.</p> <table border="1"> <thead> <tr> <th colspan="3">Water Cooled Chillers</th> </tr> <tr> <th>Chiller Capacity (kW_r)</th> <th>COP</th> <th>ISEER</th> </tr> </thead> <tbody> <tr> <td>< 260</td> <td>4.55</td> <td>5.47</td> </tr> <tr> <td>≥ 260 & < 530</td> <td>4.7</td> <td>5.29</td> </tr> <tr> <td>≥ 530 & < 1050</td> <td>5.47</td> <td>6.09</td> </tr> <tr> <td>≥ 1050 & < 1580</td> <td>5.64</td> <td>7.28</td> </tr> <tr> <td>≥ 1580</td> <td>6.06</td> <td>7.75</td> </tr> </tbody> </table> <table border="1"> <thead> <tr> <th colspan="3">Air Cooled Chillers</th> </tr> <tr> <th>Chiller Capacity (kW_r)</th> <th>COP</th> <th>ISEER</th> </tr> </thead> <tbody> <tr> <td>< 260</td> <td>2.8</td> <td>3.6</td> </tr> <tr> <td>≥ 260 & < 530</td> <td>2.8</td> <td>3.6</td> </tr> <tr> <td>≥ 530</td> <td>2.9</td> <td>3.7</td> </tr> </tbody> </table> <p>✓ Chiller ratings shall be based on IS16590: 2017</p>	Water Cooled Chillers			Chiller Capacity (kW _r)	COP	ISEER	< 260	4.55	5.47	≥ 260 & < 530	4.7	5.29	≥ 530 & < 1050	5.47	6.09	≥ 1050 & < 1580	5.64	7.28	≥ 1580	6.06	7.75	Air Cooled Chillers			Chiller Capacity (kW _r)	COP	ISEER	< 260	2.8	3.6	≥ 260 & < 530	2.8	3.6	≥ 530	2.9	3.7	<p>✓ Requirements of both COP and ISEER shall be met</p> <table border="1"> <thead> <tr> <th colspan="3">Water Cooled Chillers</th> </tr> <tr> <th>Chiller Capacity (kW_r)</th> <th>COP</th> <th>ISEER</th> </tr> </thead> <tbody> <tr> <td>< 260</td> <td>5.08</td> <td>5.31</td> </tr> <tr> <td>≥ 260 & < 530</td> <td>5.45</td> <td>6.90</td> </tr> <tr> <td>≥ 530 & < 1050</td> <td>5.64</td> <td>7.40</td> </tr> <tr> <td>≥ 1050 & < 1580</td> <td>6.13</td> <td>7.84</td> </tr> <tr> <td>≥ 1580</td> <td>6.34</td> <td>8.05</td> </tr> </tbody> </table> <table border="1"> <thead> <tr> <th colspan="3">Air Cooled Chillers</th> </tr> <tr> <th>Chiller Capacity (kW_r)</th> <th>COP</th> <th>ISEER</th> </tr> </thead> <tbody> <tr> <td>< 260</td> <td>2.8</td> <td>3.6</td> </tr> <tr> <td>≥ 260 & < 530</td> <td>2.9</td> <td>4.1</td> </tr> <tr> <td>≥ 530</td> <td>2.9</td> <td>4.3</td> </tr> </tbody> </table>	Water Cooled Chillers			Chiller Capacity (kW _r)	COP	ISEER	< 260	5.08	5.31	≥ 260 & < 530	5.45	6.90	≥ 530 & < 1050	5.64	7.40	≥ 1050 & < 1580	6.13	7.84	≥ 1580	6.34	8.05	Air Cooled Chillers			Chiller Capacity (kW _r)	COP	ISEER	< 260	2.8	3.6	≥ 260 & < 530	2.9	4.1	≥ 530	2.9	4.3	<p>✓ Requirements of either COP or ISEER shall be met</p> <table border="1"> <thead> <tr> <th colspan="3">Water Cooled Chillers</th> </tr> <tr> <th>Chiller Capacity (kW_r)</th> <th>COP</th> <th>ISEER</th> </tr> </thead> <tbody> <tr> <td>< 260</td> <td>5.08</td> <td>6.6</td> </tr> <tr> <td>≥ 260 & < 530</td> <td>5.53</td> <td>7.4</td> </tr> <tr> <td>≥ 530 & < 1050</td> <td>6.03</td> <td>8.2</td> </tr> <tr> <td>≥ 1050 & < 1580</td> <td>6.33</td> <td>8.7</td> </tr> <tr> <td>≥ 1580</td> <td>6.60</td> <td>9.0</td> </tr> </tbody> </table> <table border="1"> <thead> <tr> <th colspan="3">Air Cooled Chillers</th> </tr> <tr> <th>Chiller Capacity (kW_r)</th> <th>COP</th> <th>ISEER</th> </tr> </thead> <tbody> <tr> <td>< 260</td> <td>N/A</td> <td>N/A</td> </tr> <tr> <td>≥ 260 & < 530</td> <td>N/A</td> <td>N/A</td> </tr> <tr> <td>≥ 530</td> <td>N/A</td> <td>N/A</td> </tr> </tbody> </table> <p>✓ Air cooled chillers not allowed at Level III</p>	Water Cooled Chillers			Chiller Capacity (kW _r)	COP	ISEER	< 260	5.08	6.6	≥ 260 & < 530	5.53	7.4	≥ 530 & < 1050	6.03	8.2	≥ 1050 & < 1580	6.33	8.7	≥ 1580	6.60	9.0	Air Cooled Chillers			Chiller Capacity (kW _r)	COP	ISEER	< 260	N/A	N/A	≥ 260 & < 530	N/A	N/A	≥ 530	N/A	N/A
Water Cooled Chillers																																																																																																														
Chiller Capacity (kW _r)	COP	ISEER																																																																																																												
< 260	4.55	5.47																																																																																																												
≥ 260 & < 530	4.7	5.29																																																																																																												
≥ 530 & < 1050	5.47	6.09																																																																																																												
≥ 1050 & < 1580	5.64	7.28																																																																																																												
≥ 1580	6.06	7.75																																																																																																												
Air Cooled Chillers																																																																																																														
Chiller Capacity (kW _r)	COP	ISEER																																																																																																												
< 260	2.8	3.6																																																																																																												
≥ 260 & < 530	2.8	3.6																																																																																																												
≥ 530	2.9	3.7																																																																																																												
Water Cooled Chillers																																																																																																														
Chiller Capacity (kW _r)	COP	ISEER																																																																																																												
< 260	5.08	5.31																																																																																																												
≥ 260 & < 530	5.45	6.90																																																																																																												
≥ 530 & < 1050	5.64	7.40																																																																																																												
≥ 1050 & < 1580	6.13	7.84																																																																																																												
≥ 1580	6.34	8.05																																																																																																												
Air Cooled Chillers																																																																																																														
Chiller Capacity (kW _r)	COP	ISEER																																																																																																												
< 260	2.8	3.6																																																																																																												
≥ 260 & < 530	2.9	4.1																																																																																																												
≥ 530	2.9	4.3																																																																																																												
Water Cooled Chillers																																																																																																														
Chiller Capacity (kW _r)	COP	ISEER																																																																																																												
< 260	5.08	6.6																																																																																																												
≥ 260 & < 530	5.53	7.4																																																																																																												
≥ 530 & < 1050	6.03	8.2																																																																																																												
≥ 1050 & < 1580	6.33	8.7																																																																																																												
≥ 1580	6.60	9.0																																																																																																												
Air Cooled Chillers																																																																																																														
Chiller Capacity (kW _r)	COP	ISEER																																																																																																												
< 260	N/A	N/A																																																																																																												
≥ 260 & < 530	N/A	N/A																																																																																																												
≥ 530	N/A	N/A																																																																																																												

Tips and Best Practices

Chiller Cooling

- The latest version of ECBC 2017 (November 2019) lists ISEER values that are primarily derived for typical commercial buildings (office buildings, retail spaces, hotels and hospitals), for which Part Load Performance is an important criterion to ensure high performance. ISEER represents performance at 100%, 75%, 50% and 25% loads. However, loads in data centers do not vary as with typical commercial buildings, and data centers often operate at close to constant load throughout the year. Hence, it is important to select chillers based on the performance at the loads that are actually anticipated. Chillers can be designed for optimum COP or ISEER performance. At Level III recommendation, it will be very hard to find chillers that can meet both requirements. Therefore, the recommendation is to meet either the COP or the ISEER at Level III. The chiller selection should be based on actual conditions which are not necessarily the rated conditions. For example, chillers for data centers often run at higher (more efficient) temperatures that standard rating conditions.
- The 2017 ECBC [at 5.2.2.1 (c)] implicitly requires water-cooled chillers to serve the majority of loads (>66%) for buildings with the high cooling requirements (>530 kW), unless local regulations dictate otherwise. Water-cooled chiller plants are generally more energy efficient than air-cooled chillers as well as being cost effective.
- BEE's Schedule 21 star rating for chillers lists a minimum COP for all performance levels but establishes higher ISEER for higher star ratings.
- The ECBC recently changed from the AHRI Standard to the IS version (IS16590: 2017). There are a number of differences between these standards including the fouling factor, cooling water intake temperatures and part load weighted average hours. Hence the COP and ISEER values are different.
- Chillers designed for operation at different temperatures should also be rated at BEE Schedule 21 and IS 16590 conditions to show ECBC compliance.

- Chiller performance is required to be compliant at the rating conditions stated. However, the chiller should be selected, and the chiller plant optimized, for the actual weather data and operation for the site.
- For plants dedicated to data centers (recommended), much higher chilled-water temperatures are possible than at the standard rating conditions. These higher temperatures allow both significantly higher chiller efficiency and higher cooling capacity than would be possible at the standard conditions with the same chiller. Chilled water temperatures above the dew point of the air in the data center also will prevent inadvertent dehumidification.
- Higher chilled-water temperatures allow more hours of operation from water-side economizers. (Refer to Economizer section.) Extending this concept, it is possible to design a liquid-cooled data center with a cooling water temperature high enough that the chillers can be eliminated entirely, and cooling towers or dry coolers alone will suffice. In order for this to work, the fluid must be in close proximity to the heat sources (e.g., “direct touch” liquid cooling) and the peak annual outdoor wet-bulb temperature and the cooling tower approach temperature shall be low enough to produce the desired cooling water temperature.
- Other design elements to consider include variable speed chillers, multiple chillers staged to meet load, and lowest possible condenser water temperature setpoint.

WUE (Water Usage Effectiveness)

- WUE is a metric developed by Green Grid and it introduces Water Usage Effectiveness (WUE) in data centers. WUE_{source} is a source-based metric that includes water used on-site and water used off-site in the production of the energy used on-site. Typically, this adds the water used at the power-generation source to the water used on-site and shows that water/tower cooled chillers are more water efficient than air cooled chillers (see NREL reference below). To calculate WUE_{source} , annual source energy water usage and site water usage are divided by the IT equipment energy usage.

$$WUE(l/kWh)_{source} = \frac{\text{Annual Source Energy Water Usage (l)} + \text{Annual Site Water Usage (l)}}{\text{IT Equipment Energy (kWh)}}$$

Resources

Bureau of Energy Efficiency, Schedule 21—Chillers, 14 September 2018. Values required for 1, 3, and 5-star ratings in tables above current through December 2020. [Link](#).

Bureau of Indian Standards, Water Cooled Chilling Packages Using the Vapour Compression Cycle – Specification, BIS IS 16590:2017. [Link](#).

Data Centers are Warming Up to a New Cooling Design. Operate at higher temperature for better efficiency and cost savings, 2020, Prashant Hegde, Director, Chiller Solutions, Johnson Controls. [Link](#)

Water Usage Effectiveness (WUE™): A Green Grid Data Center Sustainability Metric. White Paper, 2011. Michael Patterson. [Link](#)

Consumptive Water Use for U.S. Power Production, 2003, P. Torcellini, NREL. Evaporative cooling systems have been criticized for their water use while less efficient air-cooled condensers are touted as low-water consumers. This ignores the additional water used at the power plant. This study of water consumption in power plants shows that evaporative building cooling systems are often more water efficient overall. [Link](#)



Cooling towers reject the heat collected by the chilled-water system. The power required by the cooling tower fans is relatively modest, but efficiency gains can be realized. ECBC 2017 provides cooling tower requirements.

Level I	Level II	Level III
<p><u>ECBC Compliant</u></p> <p>ECBC 2017 Section 5.3.4: Cooling Towers</p> <ul style="list-style-type: none"> ✓ Equipment Type: Open circuit cooling tower fans. ✓ Rating Condition: <ul style="list-style-type: none"> 35°C entering water 29°C leaving water 24°C WB outdoor air ✓ Performance: <ul style="list-style-type: none"> 0.017 kW/kWr or 0.31 kW/l/s <p><u>Recommended Additional Requirements</u></p> <ul style="list-style-type: none"> ✓ Performance: <ul style="list-style-type: none"> 0.015 kW/kWr or 0.31 kW/l/s 	<p><u>ECBC+</u></p> <ul style="list-style-type: none"> ✓ Cooling tower fans shall be variable speed. <p><u>Recommended Additional Requirements</u></p> <ul style="list-style-type: none"> ✓ For chiller plants ≤ 530kWr tower performance shall not exceed 0.012 kW/kWr or 0.25 kW/l/s at the rated conditions. ✓ For chiller plants > 530 kWr tower performance shall not exceed 0.006 kW/kWr or 0.13 kW/l/s at the rated conditions. 	<p><u>SuperECBC</u></p>

Tips and Best Practices

- Cooling tower performance is required to be compliant at the rating conditions stated (including an assumed chiller efficiency), but the actual weather data and plant design for the site should be used in the cooling tower selection and overall chiller plant optimization.
- Larger cooling towers generally are more efficient than smaller ones, thus the requirement that data centers rated at ECBC+ and Super ECBC have more efficient cooling towers in the larger plants.
- Note that the ratios between the kW/kWr and kW/l/s numbers vary because the required efficiency of the chiller varies with size and ECBC performance level. A more-efficient chiller requires less condenser water flow at the given temperature difference (rating conditions). The recommended 0.25 and 0.13 kW/l/s numbers are based on the flow that ECBC+ compliant chillers would need to achieve 0.012 and 0.006 kW/kWr at the rating conditions. In the case of ECBC compliant, the recommended change to 0.015 kW/kWr was calculated based on the flow needed to achieve 0.31 kW/l/s with ECBC compliant chillers at the rated conditions.

Adiabatic Cooling

- Adiabatic cooling generally involves wet (evaporation) and dry cooling. It works by using evaporation to pre-cool the air flowing through an air-cooled closed loop coil or wets the coil so water can evaporate directly from the air side of the coil surface. Adiabatic cooling towers are available that reduce water consumption by working in a dry mode when air temperatures are cool and a wet mode when the load or temperatures are higher.
- While saving water, adiabatic coolers typically use more fan energy and have higher approach temperatures. Adiabatic cooling towers can take a third or more energy to accomplish the same reduction in temperature as an evaporative cooling tower. Adiabatic

cooling towers also take significantly more space. Actual energy use and space required is dependent on many factors such as the tower design, outside air temperature and humidity, operating temperatures, and maintenance.

- Evaporative cooling is accomplished with a series of cooling mister nozzles, wetted pads, thin film fill or plastic mesh.
- Mist nozzles need treated water (e.g., purified), or the system will require regular cleaning. Anytime water that hasn't been de-ionized or distilled evaporates completely, minerals are left behind, so scale will accumulate.

Resources

Best Management Practice #10: Cooling Tower Management. Online guide, current. US DOE EERE. The thermal efficiency and longevity of the cooling tower and equipment depend on the proper management of recirculated water. This resource contains links to additional references. [Link](#).



ECBC 2017 provides efficiency requirements for chilled water and condenser water pumps at the ECBC Compliant, ECBC+ and SuperECBC levels.

Level I	Level II	Level III
<p><u>ECBC Compliant</u></p> <p>ECBC 2017 Section 5.3.2: Pumps</p> <ul style="list-style-type: none"> ✓ Chilled-Water Pump (Primary and Secondary) (maximum): 18.2 W/kWr with VFD on secondary pump. ✓ Condenser Water Pump (maximum): 17.7 W/kWr. ✓ Pump Efficiency (minimum): 70%. <p>ECBC 2017 Section 5.3.7.1: Variable Fluid Flow</p> <ul style="list-style-type: none"> ✓ HVAC pumping systems having a total pump system power exceeding 7.5 kW shall be designed for variable fluid flow and shall be capable of reducing pump flow rates to an extent which is lesser or equal to the limit, where the limit is set by the larger of: <ul style="list-style-type: none"> (a) 50% of the design flow rate, or (b) the minimum flow required by the equipment manufacturer for proper operation of chillers or boilers. 	<p><u>ECBC+</u></p> <ul style="list-style-type: none"> ✓ Chilled-Water Pump (Primary and Secondary) (maximum): 16.9 W/kWr with VFD on secondary pump. ✓ Condenser Water Pump (maximum): 16.5 W/kWr. ✓ Pump Efficiency (minimum): 75%. 	<p><u>SuperECBC</u></p> <ul style="list-style-type: none"> ✓ Chilled-water Pump (Primary and Secondary) (maximum): 14.9 W/kWr with VFD on secondary pump. ✓ Condenser Water Pump (maximum): 14.6 W/kWr. ✓ Pump Efficiency (minimum): 85%.

Tips and Best Practices

Standard Condition

All pump systems should be optimized for site design water-flow rate and shall also be rated at pump power/chiller tonnage as per BEE/ IS 16590 condition as noted in the chiller section above. The pump system efficiencies (W/kWr) in the above table all are premised on the same pumping head (30m for chilled-water pumps, and 24m for condenser water pumps). It is possible to design each of these systems with significantly lower heads, resulting in lower W/kWr values.

Pump Power

An electric pump system consists of active elements including a variable speed controller (optional), the motor, the transmission (typically direct drive), and the pump, as well as passive elements including the piping, heat exchangers, and other components through which the water flows. The power demand of the pump system depends on the water flow rate, the

resistance to the water flow imposed by the passive components, and the efficiency of each of the active system components. Generally, it is possible to design for higher efficiencies than required by ECBC, for example by reducing the pump head, as noted above.

Water Flow Rate

If the water flow rate can be reduced, pump energy will be saved. To reduce the water flow and still successfully handle the cooling load, the temperature difference between the supply and return water (the “delta-T”) must increase. As chillers themselves have become more efficient over time, overall chiller plant efficiency tends to be optimized at larger delta Ts (slightly more chiller energy but significantly less pump energy). The loads must be designed and operated consistent with the higher delta T. In data centers, good air management means higher return air temperatures to the CRAH units, which means higher chilled-water return temperatures, facilitating a higher delta T.

Also, modern chillers are capable of variable-flow chilled-water operation, which means control valves should be two-way to minimize bypass, and pumps should include variable-speed drives to match flow to load.

Pressure Drop

The power required by a pump increases with the resistance (the “pressure drop”, or “head”) experienced by its water flow, and the pressure drop increases exponentially with the water flow rate. Significant energy savings are realized by minimizing resistance to flow throughout the water loop. Tips include:

- **Filters and suction diffusers.** Select low pressure drop filters. After commissioning, consider removing suction diffusers for additional energy savings. Designing the system to have relatively long, straight inlets to the pumps will help ensure smooth inlet flow.
- **Flow and pressure control valves.** Select low pressure drop flow control valves. Implementing a variable flow system can remove the need for pressure control valves, providing additional energy savings.
- **Pressure setpoint.** Variable speed pumps are typically controlled to maintain a constant pressure setpoint at the far end of the loop. The setpoint needs to be high enough to successfully deliver cooling water to its destination but setting it too high wastes energy. Reset the setpoint based on control valve position to satisfy all loads (reduce pump speed until at least one valve is wide open) with a minimum of pump energy.
- **Piping.** Pipes with a large cross-section and gentle bends offer less flow resistance.
- **Balancing valves.** If the water distribution system has multiple branches, it will likely have balancing valves. During commissioning, make sure that at least one of the valves is wide open. Also consider eliminating balancing valves—systems with variable speed and modulating temperature control valves are self-balancing.

Active Component Efficiency

The table above specifies required overall pump system efficiency in terms of power required per unit of cooling provided, as well as pump efficiencies. The required overall pump system values can be attained by reducing load as described in the sections above, and focusing on the efficiency of each active pump system component, in the section below:

- **Variable Speed Drive.** Electronically Commutated Motors (ECMs) currently provide the highest efficiency variable speed control capability. Variable-Frequency Drives (VFDs) on induction motors are also a good choice.

- **Pump Motor.** Select the highest efficiency pump motor. Since most pumps are direct drive, they turn at the same speed as the motor. Higher-efficiency induction motors tend to have lower slip, meaning they will drive the pump faster. To first order, a 1% increase in speed results in 3% more power usage, so careful motor selection is needed to avoid negating efficiency gains. Note that this is not a problem if the motor is on a VFD.
- **Pump.** Required pump efficiencies are specified in the table above. Select pumps to provide their rated efficiency at the most prevalent operating condition (flow and pressure) anticipated in your system.

Pump Speed Control

Variable flow systems are required by ECBC hydronic systems with a total pump power of more than 7.5 kW and are subject to energy efficiency requirements; Refer to the above table. Pump speed control offers possible energy savings in two ways:

- The pump is set to a fixed speed that yields the desired constant water flow rate, without needing to choke the water flow path to fight against full pump speed.
- An automatic control scheme varies the water flow rate depending on the thermal load. A system with modulating control valves and speed control based on constant differential pressure (or better, as noted above, pressure reset) are examples of this scheme. Monitoring valve positions is another option for variable speed control by reducing the motor speed until at least one valve is wide open.

Speed control does not ensure efficient operation. The water flow path still can be overly restrictive or more water can be moved than is necessary. Further the pump system components can still be inefficient. The W/kWh efficiency requirements in the table above are a step toward addressing these issues, but improvements are possible in all areas as noted above.

Variable Primary Flow Systems

Variable primary flow chilled-water loop. Chilled-water distribution systems are commonly designed as two linked loops – a primary, constant-flow loop to circulate water through the evaporator heat exchanger of the chillers, and a secondary, variable flow loop to circulate water through the cooling coils. A more efficient arrangement is to have a single variable flow loop that serves both purposes. Care should be taken to ensure the minimum flow required by the chillers is always met.

Resources

HVAC Chilled-Water Distribution Schemes. Guide. A Bhatia, Continuing Education and Development, Inc. A system is a cooling system in which chilled water is circulated through cooling coils in order to provide space cooling. The principal objectives of chilled-water pumping system selection and design are to provide the required cooling capacity to each load, to promote the efficient use of refrigeration capacity in the plant, and to minimize pump energy consumption subject to budgetary constraints. [Link](#).

Chilled-Water Plant Design Guide. Guide, 2009. Energy Design Resources. Target audience: Mechanical engineers who design, redesign or retrofit chilled-water plants. The guide provides engineering information on how to estimate plant loads; details on chillers, towers and other plant equipment; system piping arrangements and configurations; controls; design approaches; contract documents; and commissioning. While design engineers are the primary audience, the guide also provides useful information for operation and maintenance personnel, mechanical contractors, and building managers. [Link](#).

Chiller Plant - Performance Approach



Buildings may show compliance by optimizing the total system efficiency for the chiller plant instead of the individual components covered by the prescriptive requirements. This alternate compliance approach can apply to central chilled-water plants in all building types, including data center projects. The total annual average power per annual average kW of refrigeration load shall be less than or equal to the maximum thresholds specified below.

Equipment included in the central chilled-water plant for this alternate approach are chillers, chilled-water pumps, condenser water pumps, and the cooling tower fan(s). Compliance checks will be based on an annual hourly simulation.

Level I	Level II	Level III
<p><u>ECBC Compliant</u></p> <p>ECBC 2017 Section 5.3.13: Total System Efficiency – Alternate Compliance Approach</p> <p>✓ Water Cooled Chiller Plant Maximum Threshold (kW/kWr) of 0.26.</p> <p><u>Recommended Additional Requirements</u></p> <p>✓ Maximum kW/kWr for plants <260kW: 0.271 >=260 and <530 kW: 0.264 >=530 and <1050 kW: 0.234 >=1050 kW: 0.228 >=1580 kW: 0.216</p>	<p><u>ECBC+</u></p> <p>✓ Maximum Threshold (kW/kWr) of 0.23.</p> <p><u>Recommended Additional Requirements</u></p> <p>✓ Maximum kW/kWr for plants <260kW: 0.242 >=260 and <530 kW: 0.229 >=530 and <1050 kW: 0.217 >=1050 and <1580 kW: 0.203 >=1580 kW: 0.197</p>	<p><u>SuperECBC</u></p> <p>✓ Maximum Threshold (kW/kWr) of 0.20.</p> <p><u>Recommended Additional Requirements</u></p> <p>✓ Maximum kW/kWr for plants <260kW: 0.238 >=260 and <530 kW: 0.222 >=530 and <1050 kW: 0.201 >=1050 kW: 0.194 =1580 kW: 0.187</p>

Tips and Best Practices

- Recommendation is to specify overall chiller plant performance. Overall chiller plant performance should not be more than the summation of individual component performance.
- Note that the allowed performance per ECBC 5.3.13 is the sum of the worst-case allowances for chillers (ISEER of the smallest size range), and the design power of the pumps and cooling towers. The Recommended Additional Requirements above account for the better performance of larger chillers as required by ECBC 2017 Chiller Sections 5.2.2.1 and 5.3.1.
- Performance requirements are to be based on standard rating conditions. Plants with a water-side economizer (see economizer section) and/or running at higher (e.g. non-condensing) temperatures should perform much better on an annual basis than the maximum allowances specified here.
- Per ECBC 5.3.13, “Compliance check will be based on annual hourly simulation” and is site/project specific. The chiller plant performance will be based on actual load, weather, and control system for the site and not on standard rating conditions.

- Data centers often run at loads well below design. Plant configuration and equipment selection should be designed for scalability and high performance at all loads. Performance should be evaluated at part load conditions of 33, 66, and 100%.

Resources

Design Brief: Chiller Plant Efficiency. [Energy Design Resources](#). Chilled water-based cooling systems are frequently used to air condition large office buildings or campuses that encompass multiple buildings. They represent a large investment from the perspective of first cost, physical space they require within the building, as well as energy and maintenance cost. Yet despite these fiscal and spatial impacts, many chiller plants do not reach their potential from the standpoint of energy efficiency. [Link](#).

Chilled-Water Plant Design Guide. 2009. [Energy Design Resources](#). (See previous section for general description) [Link](#).

4. Electrical System

The measure types in this section address the different components of the data center electrical system.

Uninterruptible Power Supply (UPS)



ECBC 2017 adopted requirements for UPSs for all ECBC levels. Requirements for UPSs apply to all buildings.

Level I	Level II	Level III
<p><u>ECBC Compliant</u></p> <p>ECBC 2017 Section 7.2.7: Uninterruptible Power Supply (UPS)</p> <ul style="list-style-type: none"> ✓ UPSs with kVA <20 shall have minimum efficiency of 90.2% at 100% load. ✓ UPSs with $20 \leq \text{kVA} \leq 100$ shall have minimum efficiency of 91.9% at 100% load. ✓ UPSs with kVA > 100 shall have minimum efficiency of 93.8% at 100% load. <p><u>Recommended Additional Requirements</u></p> <ul style="list-style-type: none"> ✓ UPS efficiency defined at all Levels shall be measured in double conversion mode for static UPSs. 	<p><u>ECBC+</u></p> <p><u>Recommended Additional Requirements</u></p> <ul style="list-style-type: none"> ✓ UPS systems with kVA < 20 shall have minimum efficiency 93.5% ✓ UPS systems with $20 \leq \text{kVA} \leq 100$ shall have minimum efficiency 94.5% ✓ UPS systems with kVA > 100 shall have minimum efficiency of 96% and shall maintain that efficiency for 25%, 50%, and 100% full load. 	<p><u>SuperECBC</u></p> <p><u>Recommended Additional Requirements</u></p> <ul style="list-style-type: none"> ✓ UPS systems with kVA < 20 shall have minimum efficiency 94.5% ✓ UPS systems with $20 \leq \text{kVA} \leq 100$ shall have minimum efficiency 95% ✓ UPS systems with kVA > 100 shall have minimum efficiency of 97% ✓ Efficiency of UPS systems ≥ 20 kVA shall be maintained for 25%, 50%, and 100% full load.

Tips and Best Practices

Harmonic Distortion

- Losses increase with input total harmonic distortion (THDi) resulting in higher temperatures and lower efficiency as well as reduced electrical equipment life (e.g., transformers).
- The efficiency impact of THDi increases as the load increases.
- Reduce or control THDi to less than 5% with power factor correction within the UPS or with input filtering.

UPS Testing and Settings

- The BIS/IEC 62040-3 standard should be followed as the test method for UPS performance.
- The overall UPS system efficiency in operation should be considered as well as the rated or nominal efficiency of the UPS modules. The system efficiency should be optimized (selected and operated) over the range of actual loads in the data center. For example, for a double-fed system, the UPS will typically not be loaded over 40%, so the efficiency of the modules as well as the number in operation are important for

overall efficiency. Energy can be saved by operating UPS systems in their most efficient range.

- Newer UPSs achieve higher efficiencies at a wider range of loads. Figure 16 depicts the change in efficiency by load for a 2007 model UPS compared to the average of more current models (2014-2017) in about the same capacity range. UPSs often operate at low loads and the penalty can be significant especially with older systems.

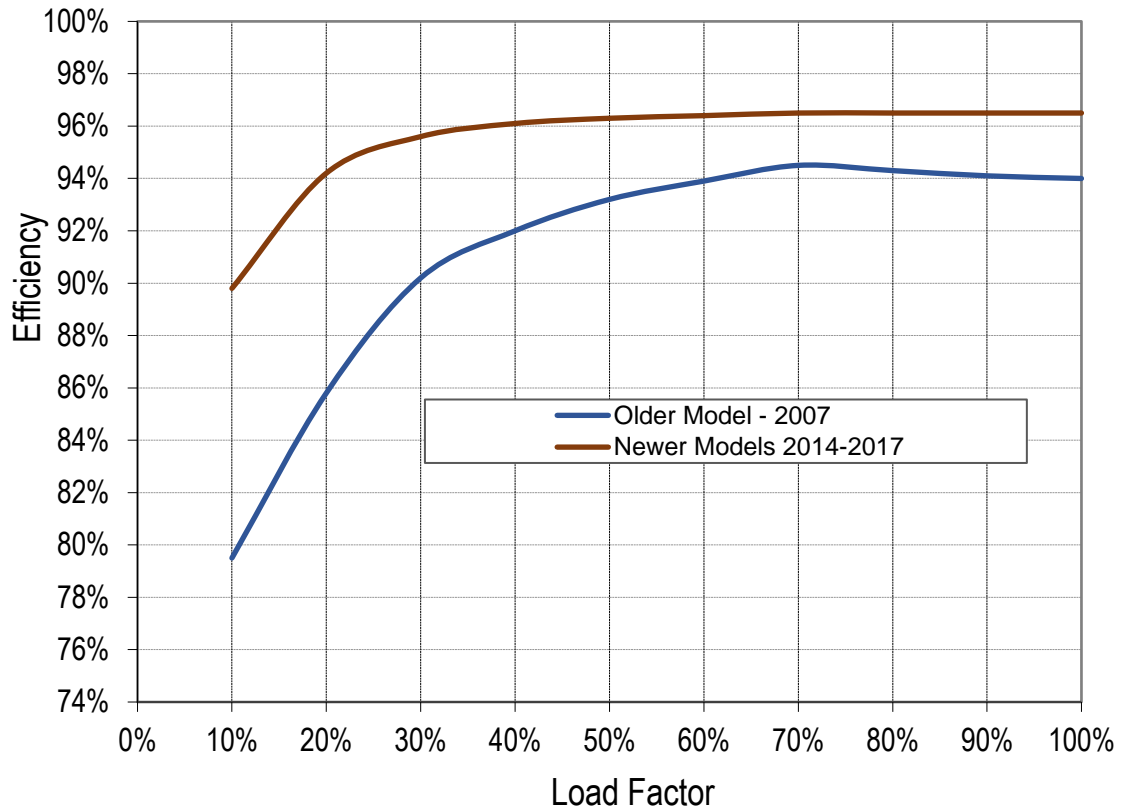

Figure 16. UPS efficiency curves: 2007 model compared to average of three 2014-2017 models, all operating in routine mode (Source: Data collected and reflected in the Electric Power Chain Tool provided by the LBNL Center for Expertise for Energy Efficiency in Data Centers, as cited below)

UPS Operational Modes

There are three modes of operation for UPS Systems, namely Double Conversion, Stand-by, and Line-Interactive. The latter two are often referred to as Eco Mode (Passive Stand-by) and Advanced Eco Mode (Active Standby and/or Line-Interactive). The latest UPS systems have improved efficiency over older models in double conversion mode, however some users are taking advantage of the even higher efficiency modes, as explained below:

- Efficiency can be further improved by selecting and operating in “Eco Mode” or equivalent (where the UPS operates in bypass under normal conditions and switches to inverter operation when needed and before the load is dropped). The efficiency of the UPSs in the graph above would be higher if operated in eco mode, however the power factor and harmonics of the load will be transferred upstream (to the utility generator and electricity board supply). Careful coordination of electrical system components needs to be part of successful eco mode operation.
- Alternately the UPS can be operated in “Advanced Eco Mode” that can (in the Line-interactive version) provide output power quality of Class I as per IEC 62040-3. While operating in this mode, the UPS keeps the inverter ON and the supplied power from the bypass is controlled for supply voltage waveform, power factor, and harmonics. There is also less time lag while the UPS operation transitions from advanced eco

mode to full inverter operation. Efficiency of the UPSs in these safe high efficiency modes can be as high as 99%.

- IEC 62040-3 defines three modes of operation for UPS Systems, namely:
 - **Double Conversion Topology:** An online mode of operation where the load is continuously supplied via two power conversions, first in the rectifier (AC to DC), then in the inverter (DC to AC), irrespective of the condition of the input power being supplied. This mode provides VFI (voltage and frequency independent) performance classified as Dynamic output performance Class 1, i.e., independent of supply (mains) voltage and frequency variations while protecting the load against adverse effects from such variations without depleting the stored energy. When the AC input supply is out of UPS preset tolerances, the UPS enters the stored energy mode of operation where the battery/inverter combination continues to support the load for the duration of the stored capacity or until the AC input returns to UPS setpoint tolerances, whichever is sooner.
 - **Stand-by Topology:** An offline mode of operation in which the load is supplied directly with AC power bypassing the batteries and inverter. Standby-by mode provides VFD (voltage and frequency dependent) performance which is classified as Dynamic output performance Class 3. Stand-by topology is often referred to as an “off-line UPS,” meaning conditioned power is fed to the load only when the AC input supply is out of tolerance. When this occurs, the UPS enters its stored energy mode of operation and the load is transferred to the inverter. The battery/inverter combination maintains continuity of the power until the stored capacity is depleted or until the AC supply returns to within the preset tolerances. While operating in the Stand-by mode, the power factor and harmonics are not regulated on the load (output) side and are passed back to the power source. Stand-by mode has two sub-options, Active and Passive. In active stand-by operation, the inverter is normally operating at no load. In passive stand-by operation, as shown in Figure 17, the inverter is normally not operating, but is activated upon an AC input disturbance or failure. In the active mode, having the inverter always on, enables faster switching to battery (storage) operation.
 - **Line-Interactive Topology:** An online mode of operation, meaning load is supplied with conditioned power via a parallel connection of the AC input and the UPS inverter. The inverter or the power interface is operating to provide output voltage conditioning and/or battery charging. The output frequency is dependent upon the AC input frequency providing VI (voltage independent) performance classified as Dynamic output performance Class 2. When the AC input supply voltage or frequency is out of UPS preset tolerances, the inverter and battery maintain continuity of power via the stored energy mode of operation. The unit runs in stored energy mode for the duration of the stored capacity or until the AC input supply returns within the UPS design tolerances, whichever is sooner. The inverter may be of bidirectional design or alternatively, the inverter may be unidirectional, and a separate energy storage charger is incorporated. The VI mode can provide high efficiency up to 99% and a few UPS manufacturers can even achieve output power quality of Class 1 as defined by IEC62040-3. While operating in this mode as shown in Figure 17 the inverter of the UPS also regulates the load power factor and harmonics to achieve UPS input current similar to the double conversion mode.

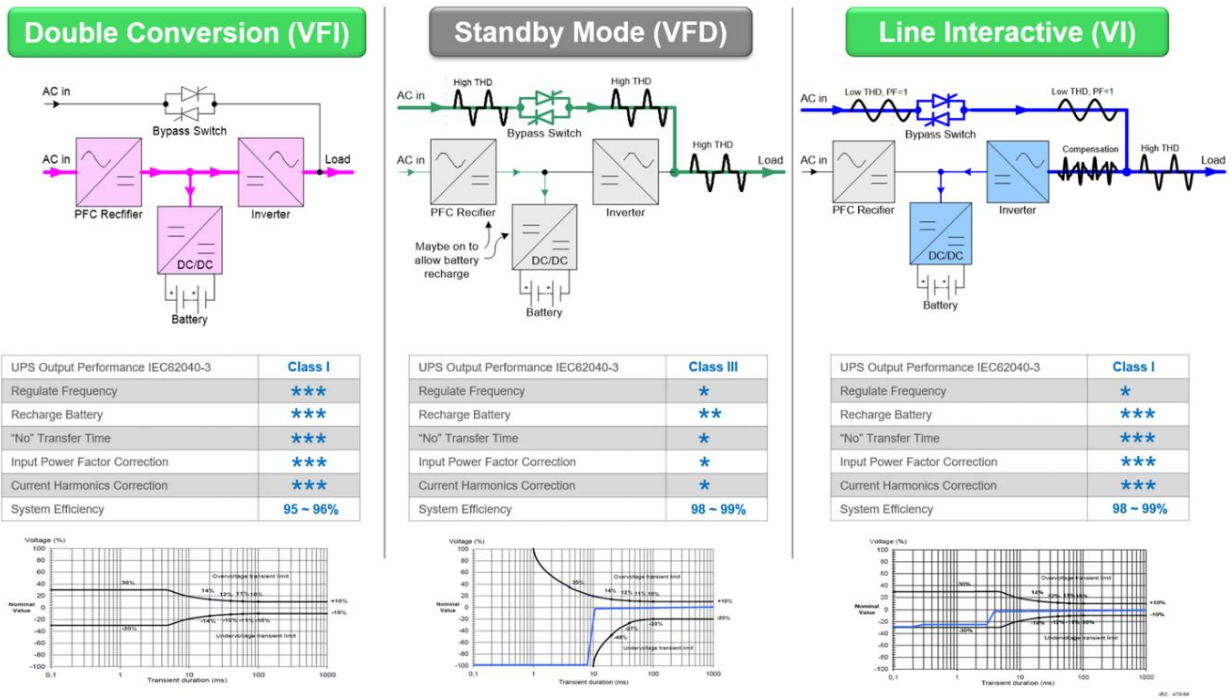

Figure 17 UPS functional modes (Passive Standby is shown for Standby Mode and Class-I is shown for Line Interactive) (Source: Schneider Electric)

Resources

A new International UPS Classification by IEC 62040-3 This paper describes the IEC 62040-3 standard for UPS performance, i.e., Uninterruptible power systems (UPS) - Part 3: Method of specifying the performance and test requirements. The latest version of the standard is 2011 see below. [Link](#)

IEC 62040-3:2011: Uninterruptible power systems (UPS) - Part 3: Method of specifying the performance and test requirements. Standard, 2011. International Electrotechnical Commission. IEC 62040-3:2011 applies to movable, stationary, and fixed electronic uninterruptible power systems (UPS) that deliver single- or three-phase, fixed-frequency AC output voltage not exceeding 1000 VAC and that incorporate an energy storage system, generally connected through a DC link. [Link](#).

Data Center Electric Power Chain Tool. Software tool, updated 2020. Lawrence Berkeley National Laboratory, Traber Engineers, EYP Mission Critical Facilities. This Excel-based tool designed to help data center owners assess the potential savings from efficiency actions in the electrical power chain of a data center (transformers, generators, UPSs, PDUs, power supplies). [Link](#).

ENERGY STAR® Program Requirements for Uninterruptible Power Supplies (UPSs). The document describes energy star rating developed for UPS system and its requirements. [Link](#).



ECBC 2017 adopted energy efficiency requirements for diesel generators. However, it only provides requirements for generators up to 19kW. Recommendations below are for diesel generators greater than 100 kW (as normally found in data centers).

Level I	Level II	Level III
<p><u>ECBC Compliant</u></p> <p>ECBC 2017 Section 7.2.3: Diesel Generator (DG) sets</p> <ul style="list-style-type: none"> ✓ Minimum 3 stars rating under BEE's Standards and Labeling Program. ✓ BEE Schedule 18 (see resources) efficiency requirements for 3 star: SFC > 245 & ≤ 272 gm/kWh <p><u>Recommended Additional Requirements</u></p> <ul style="list-style-type: none"> ✓ DGs 100<kW<300 shall have SFC less than 216 gm/kWh ✓ DGs 300<kW<600 shall have SFC less than 199 gm/kWh ✓ DGs 600<kW shall have SFC less than 175 gm/kWh 	<p><u>ECBC+</u></p> <ul style="list-style-type: none"> ✓ Minimum 4 stars rating. ✓ If the building does not use DG sets for captive power generation (no more than 15% of power requirement is being met by the use of DG sets), 3 star rated DG sets may be used for ECBC+ and Super ECBC Buildings. ✓ BEE Schedule 18 requirements for 4 stars: SFC > 220 & ≤ 245 gm/kWh <p><u>Recommended Additional Requirements</u></p> <ul style="list-style-type: none"> ✓ DGs 100<kW<300 shall have SFC less than 189 gm/kWh ✓ DGs 300<kW<600 shall have SFC less than 182 gm/kWh ✓ DGs 600<kW shall have SFC less than 163 gm/kWh 	<p><u>SuperECBC</u></p> <ul style="list-style-type: none"> ✓ 5 stars rating. ✓ BEE Schedule 18 requirements for 5 stars: SFC ≤ 220 gm/kWh <p><u>Recommended Additional Requirements</u></p> <ul style="list-style-type: none"> ✓ DGs 100<kW<300 shall have SFC less than 182 gm/kWh ✓ DGs 300<kW<600 shall have SFC less than 163 gm/kWh ✓ DGs 600<kW shall have SFC less than 155 gm/kWh

Tips and Best Practices

Right Sizing

Like many other mechanical/electrical components, generators run less efficiently at low partial loads. The design and operation of data centers should provide high performance at all potential loads. Performance should be evaluated at 33%, 66%, and 100% design load. Modular generators can be sequenced as needed to meet the actual load conditions while providing redundancy.

Heater Thermostats and Settings

Typical generators include heaters to help ensure starting and minimize engine stress when called to load rapidly after starting. Ensure that the heaters have thermostats and, in the case of generators backing up a UPS system, they are set to temperatures (e.g., 20°C) consistent with generators that can be allowed to warm up for 30-60 seconds before the transfer switch puts them under load. This arrangement varies from the more typical emergency generator that is expected to assume full load in under 10 seconds and so has temperature setpoints in the 40°C range.

Resources

Diesel Generators: Improving Efficiency and Emission Performance in India. Report, 2014. Shakti Sustainable Energy Foundation. While India's power sector struggles to provide extensive, uninterrupted and reliable grid supply, diesel generator sets assume great importance as preferred power back-up in prominent sectors like agriculture, construction, industry, households, and other commercial applications. Exhibit 4 in this reference was used in identifying recommended target efficiencies. [Link](#).

Amendment to Schedule 18 for Diesel Generator Sets. Standard, 2016. Bureau of Energy Efficiency, India. This schedule specifies the star labeling requirements for various classifications for the application, rating and performance of single-/three-phase diesel generating sets consisting of a reciprocating internal combustion (RIC) engine driven by diesel as fuel, alternating current (AC) generator, any associated control gear, switchgear and auxiliary equipment. [Link](#).



ECBC 2017 specifies requirements for metering and monitoring. Requirements are provided for ranges of electric service capacity to the building. While the ECBC Metering and Monitoring requirements are based on the overall building, the Recommended Additional Requirement thresholds recommended below are for the data center IT load only, whether it be a standalone building or imbedded in another building. The requirements shown are additive, both across from level to level (for the same load) and down from load to load (for the same level).

Level I	Level II	Level III
<p>ECBC Compliant ECBC 2017 Section 7.2.4: Metering and Monitoring</p> <ul style="list-style-type: none"> ✓ Data Centers shall be sub-metered <p>Whole Building < 65kVA</p> <ul style="list-style-type: none"> ✓ Energy (kWh) recorded hourly <p>65 – 120 kVA</p> <ul style="list-style-type: none"> ✓ Add Power (kW) and power factor <p>120 - 250 kVA</p> <ul style="list-style-type: none"> ✓ Add submetering for HVAC system and components, renewable power <p>250 – 1000 kVA</p> <ul style="list-style-type: none"> ✓ Add submetering for lighting, domestic hot water, and plug loads <p>>1000</p> <ul style="list-style-type: none"> ✓ Add power quality+ measurements <p><u>Recommended Additional Requirements</u></p> <p>Data center IT load >65 and <250 kVA:</p> <ul style="list-style-type: none"> ✓ Rack temperature and humidity monitoring at the top of every 5th rack ✓ Sub-metering for HVAC, UPS efficiency ✓ Measure PUE as per Green Grid/ISO30134-2 Level1 ✓ Energy meter to record DG Output (kWh) and meter for fuel consumption (Liters) 	<p>ECBC+</p> <p><u>Recommended Additional Requirements</u></p> <p>Data center IT load <65 kVA: Add</p> <ul style="list-style-type: none"> ✓ Rack temperature and humidity monitoring at the top of every 5th rack ✓ Measure PUE as per Green Grid/ISO30134-2 level-1 <p>Data center IT load >65 and <250 kVA: Add</p> <ul style="list-style-type: none"> ✓ Rack temperature and humidity monitoring at the top of every 3rd rack. ✓ Rack PDU - Strip level monitoring (Voltage, Ampere, Power) ✓ PUE measurement - Green Grid/ISO30134-2 Level-2. ✓ Component submeters (chillers, cooling towers, fans and pumps) ✓ water consumption ✓ Electrical distribution system losses (e.g., UPS), lighting, and UPS room AC). ✓ Supply air, return air and set point temperature of CRAC and air handler units. ✓ Battery and UPS room temperature and humidity control 	<p>SuperECBC</p> <p><u>Recommended Additional Requirements</u></p> <p>Data center IT load <65 kVA: Add</p> <ul style="list-style-type: none"> ✓ Rack temperature and humidity monitoring at the top, middle and bottom of every 5th rack ✓ UPS efficiency ✓ Load on transformer and DG ✓ PUE measurement - Green Grid/ISO30134-2 Level-2 <p>Data center IT load >65 and <250 kVA: Add</p> <ul style="list-style-type: none"> ✓ Rack temperature and humidity monitoring at the top, bottom, and middle of every 3rd rack or internal server sensors accessible by DCIM or BMS systems. ✓ PUE to be measured as per the Green Grid/ISO30134-2 Level 3. ✓ Server level power Monitoring. ✓ Data shall be available in real time in an automated data center infrastructure management (DCIM) system. ✓ Total cooling generated and cooling unit efficiency. ✓ Battery monitoring system at UPS Level and battery monitoring system at string level.

<p>Data Center IT load > 250 kVA: Add</p> <ul style="list-style-type: none"> ✓ EMS Load Managers (Load Manager at Grid Incomer + Energy Meters at all panels + PDU BCMS) ✓ Metering for chiller, thermal storage tank, make-up water tank level, cooling tower fan power, pump, VFD ✓ Alarm for temperature set-point breach 	<p>Data Center IT load > 250 kVA: Add</p> <ul style="list-style-type: none"> ✓ CRAC unit air filter status ✓ Total data center and each rack electrical capacity utilization. ✓ Water consumption of HVAC system ✓ BTU Meter (To identify Thermal Demand) ✓ Power Distribution Unit (PDU) ✓ Branch Circuit Monitoring System (BCMS). ✓ Cell / Block Level Battery monitoring System 	<p>Data Center IT load > 250 kVA: Add</p> <ul style="list-style-type: none"> ✓ Thermal (air) monitoring shall be at the inlet of the IT equipment at each server (internal sensors accessible by DCIM or BMS systems. ✓ RCI & RTI index measurement ✓ Total Data center and each rack space capacity utilization and availability. ✓ Monitor airflow delivered vs airflow required for IT load and check the ratio for < 15%.
-----------------------------------------------------------------------------------------------------------------------------------------------------------------------------------------------------------------------------------------------------------------------------------------------------------------------------------------------------------------------------	------------------------------------------------------------------------------------------------------------------------------------------------------------------------------------------------------------------------------------------------------------------------------------------------------------------------------------------------------------------------------------------------------------------------------------------------------------------------	------------------------------------------------------------------------------------------------------------------------------------------------------------------------------------------------------------------------------------------------------------------------------------------------------------------------------------------------------------------------------------------------------------------------------------------------------------------------------------------

Tips and Best Practices

Importance of Metering and Monitoring

Metering and monitoring of data center energy does not directly result in energy-efficient operation, but it enables the data center operator to track and improve performance. Real-time tracking of key metrics such as PUE and cooling kW/kWr alerts the operator to critical issues that bear on energy performance.

Additional Monitoring

Additional monitoring that should be considered in data centers includes:

- DG Set – All parameters of 50kW + Synchronization Status + Engine Controller Interface, DG Set Room Temperature, Flash Detectors, % Loading for DG Sets.
- Transformer – Winding Temperature, Oil Temperature LT Panels - Breaker Status.
- Fuel Polishing System, Bulk Storage Tank, Interconnected Valves, Oil Leakage Pipe.
- Battery Room Hydrogen Sensors.

Derived Metrics

Monitoring the points listed in the table above allows the monitoring system to automatically calculate additional metrics. Recommended metrics include:

- PUE
- Data center total electric capacity utilization
- Alarm for CRAC/air handler supply air temperature set-point breach
- UPS efficiency (output kW/Input kW)
- Cooling system percent load
- Cooling system efficiency (kW/kWr)
- Electric capacity utilization of each rack
- UPS room cooling system efficiency (kW/kWr)

Categories of power usage effectiveness measurement

Following initial work by the Green Grid, ISO/IEC standard 30134-2:2016 defines the three PUE levels or categories as follows (with IT equipment energy consumption measurement point):

- Category 1 (PUE1) — provides a basic level of resolution of energy performance data as measured at UPS output;
- Category 2 (PUE2) — provides an intermediate level of resolution of energy performance data as measured at the PDU output;

- Category 3 (PUE3) — provides an advanced level of resolution of energy performance data as measured at the IT equipment input.

The higher categories provide progressively more accurate measurements of energy usage (as the measurements are made closer to the devices that consume the energy), and greater scope for energy efficiency improvements. In all cases, the total data center energy consumption is measured from the utility service entrance or other feeds to all of the electrical and mechanical equipment used to power, cool, and condition the data center. To properly assess PUE, it is critical to account for all systems that support the data center.

Category 1 (PUE1) — Basic resolution: The IT load is measured at the output of the UPS (or equivalent) equipment and may be read:

- from the UPS front panel,
- through a meter on the UPS output, and
- in cases of multiple UPS modules through a single meter on the common UPS output bus.

Category 2 (PUE2) — Intermediate resolution: The IT load is measured at the output of the PDUs within the data center and is typically read from the PDU front panel or through a meter on the PDU output (with or without transformer, the measurement point is then after the transformer). Individual branch circuit measurement is also acceptable.

Category 3 (PUE3) — Advanced resolution: The IT load is measured at the IT equipment within the data center. This can be achieved by metering at the

- rack (e.g. plug strips) that monitors aggregate set of IT systems
- receptacle level
- IT device itself.

Block Diagram for Measurement Location by Level:

To report Level 1, Level 2 and Level 3 PUE, the required measurement location for that level must be used. For example, Level 3 must be measured at the server level and should be continuous and automatic. Additional measurement points are recommended to provide further insight into a data center infrastructure's energy efficiency. Monitoring various components of the mechanical and electrical distribution will provide further insight as to the large energy consumers and where possible efficiency gains can be made (e.g., chillers, pumps, towers, PDUs, switchgear, etc.).

In Figure 18, L1, L2 and L3 denotes the category measurement points described above.

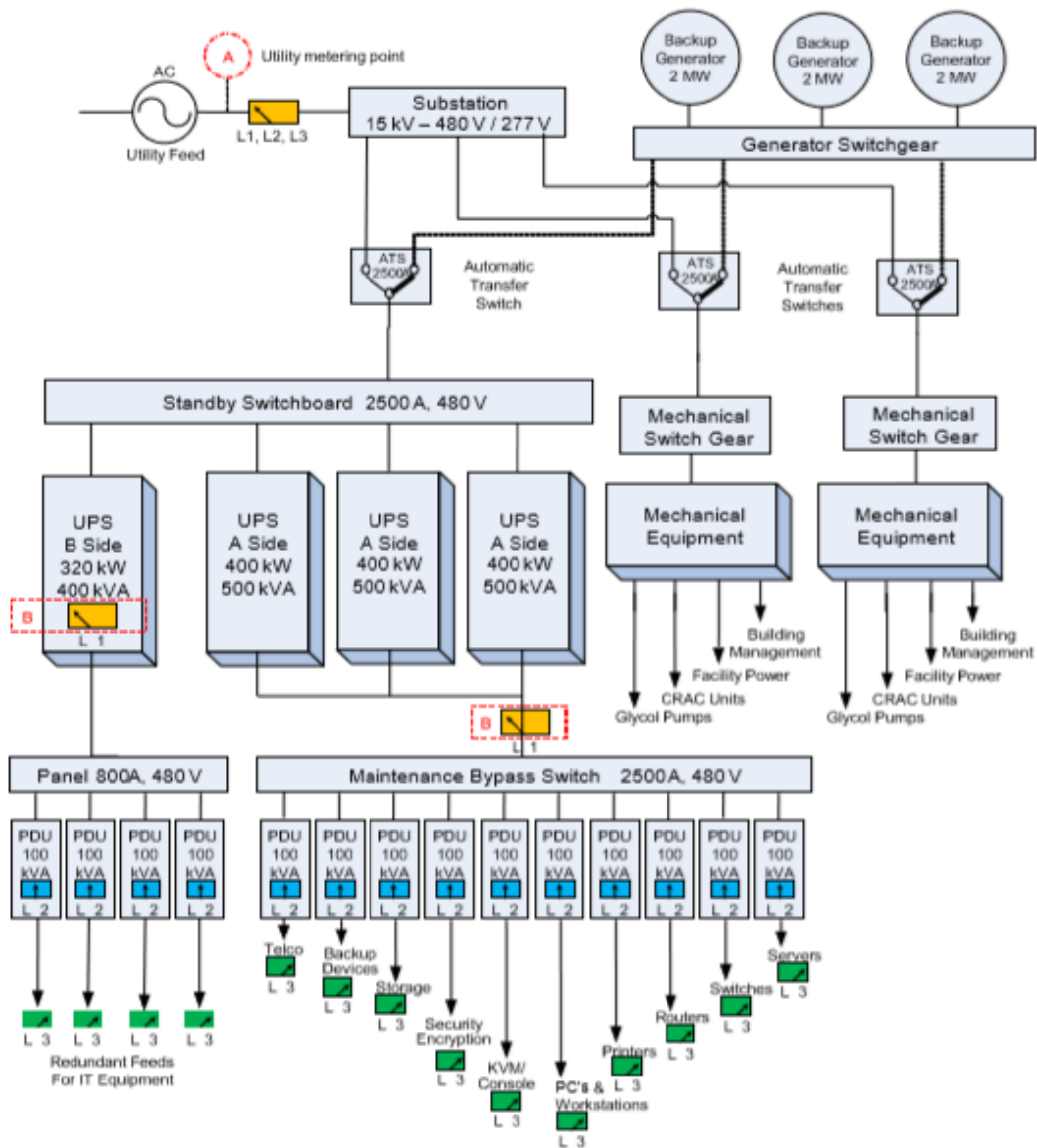

Figure 18. Block diagram with specified measuring points

Additional Monitoring

In addition to monitoring the electrical system components, environmental monitoring in data centers is needed for optimization and reliability. Temperature and humidity measurements are recommended at each level of compliance. The level of monitoring recommendations is driven by the size of the data center (kVA) and the level of compliance; however, rack density is also a consideration. For example, in racks with loads greater than 8 kW, temperature monitoring of every AC rack is recommended. Some experts recommend monitoring at the front of the rack at 1/3rd height and 2/3rd height (rather than at the top, middle, and bottom).

Resources

Data Center Metering & Resource Guide. Guide, 2017. Rod Mahdavi, Steve Greenberg, US DOE EERE. This guide intends to help data center owners and operators implement a metering system that allows their organizations to gather the necessary data for effective decision-making and energy-efficiency improvements. [Link](#).

Practical Considerations for Metering and Power Usage Effectiveness. Slides, 2017. Dale Sartor, Lawrence Berkeley National Laboratory. From Dale Sartor's August 17, 2017

presentation on metering and Power Usage Effectiveness (PUE) while participating in FEMP's Energy Exchange Data Center Panel. [Link](#).

PUE: A Comprehensive Examination of the Metric. Report, 2014. Victor Avelar, Dan Azevedo, Alan French, Green Grid. Allows executives to gain a high level of understanding of the concepts surrounding PUE, while providing in-depth application knowledge and resources to those implementing and reporting data center metrics. [Link](#).

Data centers - Key performance indicators - Part 2: Power usage effectiveness (PUE) - ISO/IEC 30134-2:2016. ISO standard covering:

- a) defines the power usage effectiveness (PUE) of a data center,
- b) introduces PUE measurement categories,
- c) describes the relationship of this KPI to a data center's infrastructure, information technology equipment and information technology operations,
- d) defines the measurement, the calculation and the reporting of the parameter,
- e) provides information on the correct interpretation of the PUE.

[Link](#)

5. IT Hardware & System Management

Though ECBC 2017 does not address the energy efficiency of information technology (IT), the advisory board decided that including IT efficiency was critical, given that IT drives power demand for the entire data center facility. Efficient IT thus saves energy in all supporting infrastructure. This section is divided into two subsections: **IT Hardware**, covering processor generation and performance, power supplies, and the design of servers and racks for better air management; and **System Management**, covering server utilization and server-level sensors and data for automated monitoring.

IT Hardware

This section provides recommended requirements for IT Hardware at three performance levels. There are currently no ECBC criteria for IT hardware.

Level I	Level II	Level III
<u>Recommended Requirements</u>	<u>Recommended Requirements</u>	<u>Recommended Requirements</u>
Processor Generation (Age)		
No Criteria	Processor: >60% No more than four years older than current generation	Processor: >60% No more than two years older than current generation
IT Equipment Environmental Performance		
ASHRAE A-2	ASHRAE A-3	ASHRAE A-4
Power Supply Hardware		
80 Plus Bronze or better for more than 75% of all server hardware.	80 Plus Gold or better for more than 75% of all server hardware	80 Plus Titanium or better for more than 75% of all server hardware
Power Type		
Power Input Type: Any	Power Input Type: Any	Power Input Type: High Voltage Direct Current (HVDC)
Airflow		
No criteria	All IT equipment designed for front-to-back airflow or retrofitted for same	All IT equipment designed for front-to-back airflow

Tips and Best Practices

Processors Generation (Age)

The advancement of processor technologies has brought significant improvement in the CPU power efficiency with achievement of greater computing power at lower electricity consumption. If a data center has a large percentage of older generation hardware, then it is a safe assumption that the same output can be achieved at a lower energy consumption with a newer generation of processors assuming the hardware is virtualized and the newer processors run at an equal or higher utilization.

For this guide, the recommended criteria are limited to the processors within the servers only. The processor count shall be defined as the number of physical processors on the mother board regardless of how the BIOS is configured to enable/disable cores/sockets. Sockets

without an installed processor are not included in the count. The virtual CPU count is not considered for this section of the guideline.

It also is recognized that there is a time lag from when a processor firm releases a new generation of processors, manufacturers tool up to produce it, and data center operators test, certify and install the new processors. The baseline for calculating “current” generation of the processor is therefore set as 12 months after servers equipped with the new processors are generally available in the world market. This baseline for current generation provides sufficient time for data center operators to install the new generation while decommissioning older systems. Since manufactures will introduce new processors at different rates, the metric for processor generation is based on how much older in years the server processors in the data center are compared to the current generation. The percent of processors under the age thresholds are measured as follows:

T_P = percent of processors meeting the specified threshold

T_H = total number of processors in the data center

T_N = total number of current processor generation (defined as latest shipping generation of processors) in the data center

T_{N+2} = total number of processors in the data center less than two years older than current generation

T_{N+4} = total number of processors in the data center less than four years older than current generation

$$T_P = \{T_N / T_H\} \times 100$$

For Level I, there is no recommended number for T_P

For Level II, the recommended number for T_P is greater than 60% of the processors are less than four years older than current generation:

$$T_P = \{(T_N / T_H) + (T_{N+4} / T_H)\} \times 100$$

For Level III, the recommended number for T_P is greater than 60% of the processors are less than two years older than current generation:

$$T_P = \{(T_N / T_H) + (T_{N+2} / T_H)\} \times 100$$

IT Environmental Performance

- Users should specify IT equipment at higher ASHRAE “A” Classes to allow for higher operating temperatures.

New IT equipment can run at higher temperatures. This provides greater resiliency when temperatures occasionally exceed the ASHRAE recommended temperature of 27°C. With allowable temperatures going all the way up to 45°C, some data centers can be designed to operate with little or no compressor-based air conditioning. The table below illustrates the ASHRAE Thermal Guidelines: “A” Class Temperature and Humidity Ranges for air cooling. (ASHRAE, 2015. [Thermal Guidelines for Data Processing Environments](#), 4th Edition. American Society of Heating, Refrigerating, and Air-Conditioning Engineers, Atlanta.) Refer to Temperature and Humidity Control section for additional information on ASHRAE recommended and allowable temperature and humidity ranges.

Table 1. ASHRAE thermal guidelines for data centers (2015 and 2016 errata)

Class	Dry Bulb (°C)	Humidity Range	Maximum Dew Point (°C)	Maximum Elevation (m)	Maximum Rate of Change (°C/hr)
Recommended					
A1 to A4	18 to 27	-9°C DP to 15°C DP and 60% rh	N/A		
Allowable					
A1	15 to 32	-12°C DP and 8% rh to 17°C DP and 80% rh	17	3,050	5*/20
A2	10 to 35	-12°C DP and 8% rh to 21°C DP and 80% rh	21	3,050	5*/20
A3	5 to 40	-12°C DP and 8% rh to 24°C DP and 85% rh	24	3,050	5*/20
A4	5 to 45	-12°C DP and 8% rh to 24°F DP and 90% rh	24	3,050	5*/20
*More stringent rate of change for tape drives					

Note that in addition to temperature and humidity ranges, maximum altitude is specified, and maximum rate of change of temperature for tape drives and all other IT equipment is specified as part of the ASHRAE Guidelines.

Power Supplies

Most IT hardware in the data center operates at voltages in the 1.2v to 12v DC range. Therefore, power from the UPS must be converted from line voltage (e.g., 220v) AC to the lower DC voltages needed in the IT hardware. Power supplies in the IT hardware have a significant impact on the overall power consumption of the equipment in the data center. Industry has gravitated to a few standards, the common ones being 80 PLUS and Energy Star.

The table below provides the efficiency expected at various levels of certification under the 80 PLUS program. 80 PLUS is a voluntary certification program intended to promote energy efficiency of the computer power supply units (PSUs). The program is administered by <https://www.plugloadsolutions.com/80PlusPowerSupplies.aspx>

Table 2. 80 PLUS voluntary standards for IT power supplies

80 Plus Test Type	115 V internal non-redundant				230 V Internal Redundant				230 V EU Internal non-redundant			
	10%	20%	50%	100%	10%	20%	50%	100%	10%	20%	50%	100%
% of Rated Load	10%	20%	50%	100%	10%	20%	50%	100%	10%	20%	50%	100%
80 Plus		80%	80%	80%						82%	85%	82%
80 Plus Bronze		82%	85%	82%		81%	85%	81%		85%	88%	85%
80 Plus Silver		85%	88%	85%		85%	89%	85%		87%	90%	87%
80 Plus Gold		87%	90%	87%		88%	92%	88%		90%	92%	89%
80 Plus Platinum		90%	92%	89%		90%	94%	91%		92%	94%	90%
80 Plus Titanium	90%	92%	94%	90%	90%	94%	96%	91%	90%	94%	96%	94%

Table summary from https://en.wikipedia.org/wiki/80_Plus

Total number of PSUs is defined as all PSUs available in the data center equipment. This shall include all connected PSUs and will not include PSUs that have been decommissioned or not connected. However, all PSUs that are connected and whether powered on or in stand by state will be considered for the computation of {total number of PSU}.

P_t = percent PSUs meeting or exceeding the specified rating, with 75% being the threshold.

P_t (Level I) = {Count of PSUs with 80PLUS Bronze Rating or better} / {Total number of PSU} x 100

P_t (Level II) = {Count of PSUs with 80PLUS Gold Rating or better} / {Total number of PSU} x 100

P_t (Level III) = {Count of PSUs with 80PLUS Titanium Rating or better} / {Total number of PSU} x 100

Power Type

The electric power chain in data centers typically involves a conversion of current from alternating to direct and back again in the UPS, and from alternating to direct again in the IT hardware power supply. Transformers also handle several other step-ups and step-downs of voltage by the time the power reaches the IT hardware. Each of these conversions is less than 100% efficient.

Providing direct current from the UPS (or even the generator) to the IT power supplies can eliminate some of these inefficiencies and provide additional benefits.

The adoption of direct current power as well as higher voltages such as 380v DC increases reliability, improves power quality and eliminates the need for complex synchronization circuits associated with multi-source AC distribution. Servers capable of running directly on high voltage direct current (HVDC) are becoming available in the market. HVDC is a “stretch” goal for Level III performance.

Internal Server Air Management

Processors and other components generate heat in servers. Heat must be removed from the servers efficiently to keep them cool and maintain performance. Figure 19 illustrates the flow of cool air into the server and hot air being discharged by the server fan. Servers consume fan energy depending on the fan speed, and fan speed varies depending on inlet air temperature and IT load.

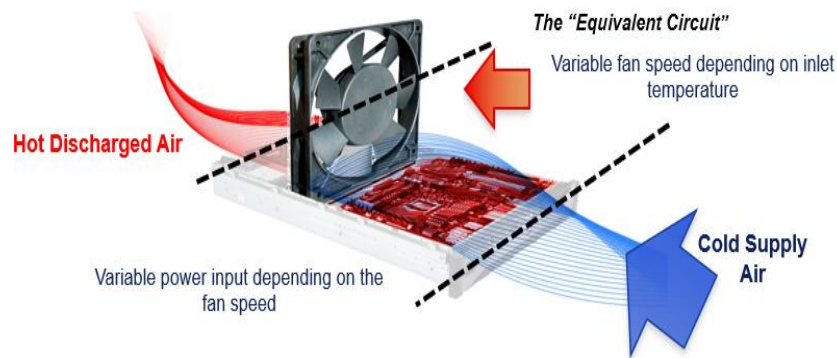

Figure 19 Supply of cool air and discharge of hot air within the server (Source: Vertiv)

Servers from different manufactures have diverse designs and capacities. The age of servers, the airflows within servers and how heat is rejected from the server can significantly affect cooling and air management requirements. Good hardware design can enhance energy efficient airflow in servers. Ideally components that are most sensitive to heat should be placed in front of components that are more tolerant or generate the most heat. Further consideration should be given to how air will physically get to the hot components. The Open Compute Project (OCP) promotes adding height to each server such that there is a large air channel that not only allows the freer flow of air, it also provides room for additional heat exchanger area in the airstream. These servers can run at very warm inlet air temperatures (typically without compressor-based cooling) with low fan energy.

Airflow - Server and Rack Design

Good data center design calls for arranging server racks with hot and cold aisles. For this to work well, IT equipment needs to be designed for front-to-back airflow. Most IT equipment meets this basic requirement; however some don't. For example, some IT equipment vents out the top or sides. Such a configuration makes it very difficult to optimize air management performance within racks, rows and the data center. Whenever possible, IT equipment should be specified or selected with a front-to-back airflow configuration. At Level II, any equipment not following that convention needs to be retrofitted with air baffles and air channels within the rack to redirect the airflow to the back of the rack. While retrofitting airflow is challenging, a number of data center operators have developed innovative approaches. At Level III, all IT equipment must be supplied in a front-to-back airflow configuration.

Many examples of IT components with front-to-back air flow are available, such as the server in Figure 20.

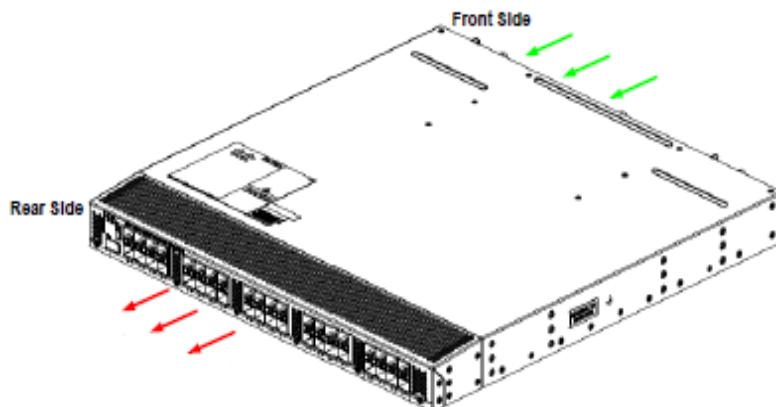

Figure 20. A common server with front-to-back air flow

Server configurations that vent hot air to the front, top or sides pose cooling and air management challenges for data center owners and operators (as shown in Figure 21).

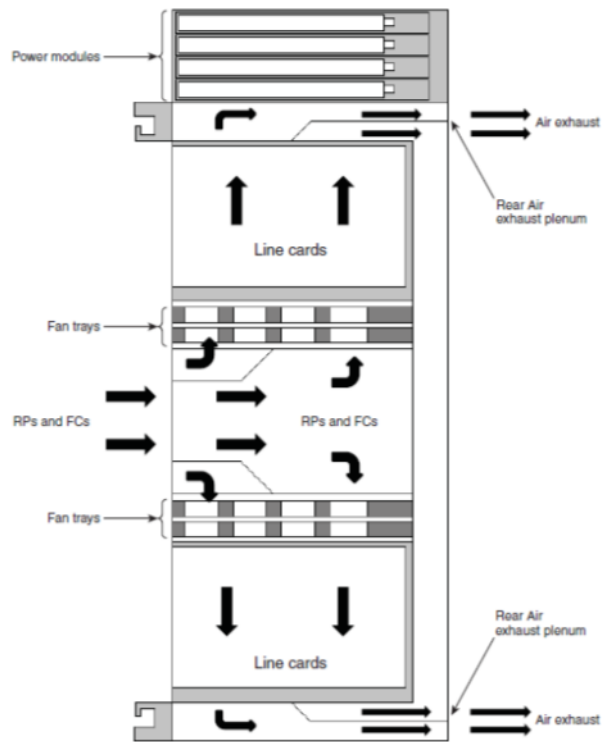

Figure 21 Airflow front to back through a server chassis but split

Sending air flow from front to back is a best practice but splitting that air flow as in Figure 21 can make internal fans work harder and thus use more energy.

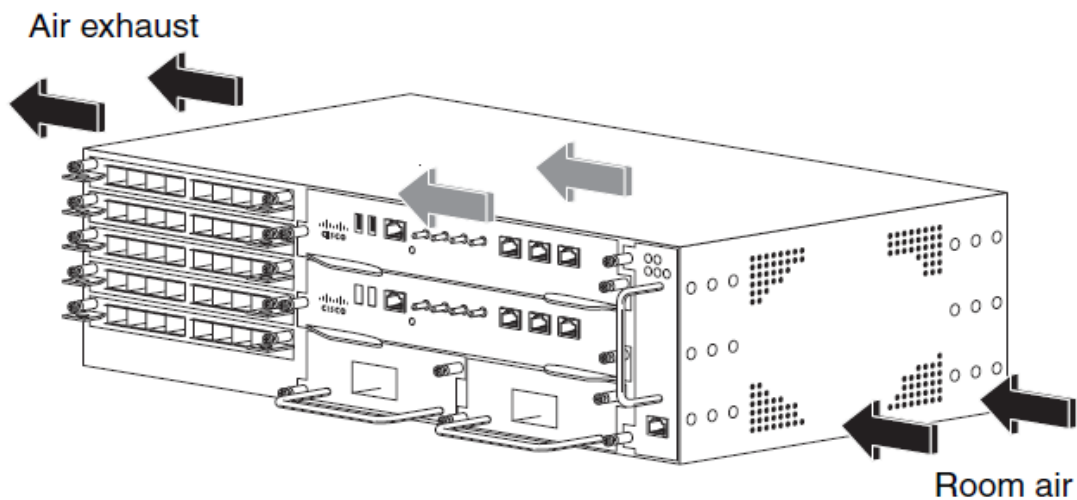

Figure 22. Airflow side to side through the chassis of a router

We adopt the recommendation of the 2018 Best Practice Guidelines for the EU Code of Conduct on Data Center Energy Efficiency (Joint Research Center, European Commission 2018) (refer to *Additional Resources 6*): “When selecting equipment for installation into cabinets ensure that the air flow direction matches the air flow design for that area. This is commonly front to rear or front to top. If the equipment uses a different air flow direction to that defined for the area into which it is installed (such as right to left when the cabinet is intended to be front to back) it should only be used with a correction mechanism such as ducts or special cabinets that divert the air flow to the defined direction.”

Systems Management

IT systems management is a vital component in ensuring that the data center continues to meet the intended performance criteria. System management includes design, procurement, training and operationalization that ensure the planned savings are actualized. This section is subdivided into Utilization and Server Monitoring and provides recommended requirements for systems management at three performance levels. There is currently no ECBC criteria for systems management.

Level I	Level II	Level III
<u>Recommended Requirements</u>	<u>Recommended Requirements</u>	<u>Recommended Requirements</u>
Server Utilization		
No criteria	Mean CPU Utilization 10 - 40%	Mean CPU Utilization >40%
IT Equipment Monitoring		
No criteria	Environmental monitoring at the IT equipment level (e.g., server temperature and airflow)	Integration of internal IT equipment environmental monitoring into building management systems (BMS) for closed loop feedback integration

Tips and Best Practices

Server Utilization

The level at which IT hardware is utilized has an important impact on the average efficiency of the system. A base level of power consumption is necessary regardless of the work being run on the hardware. Fortunately, modern server design has vastly improved the overall efficiency curve as a function of its loading as shown in Figure 23.

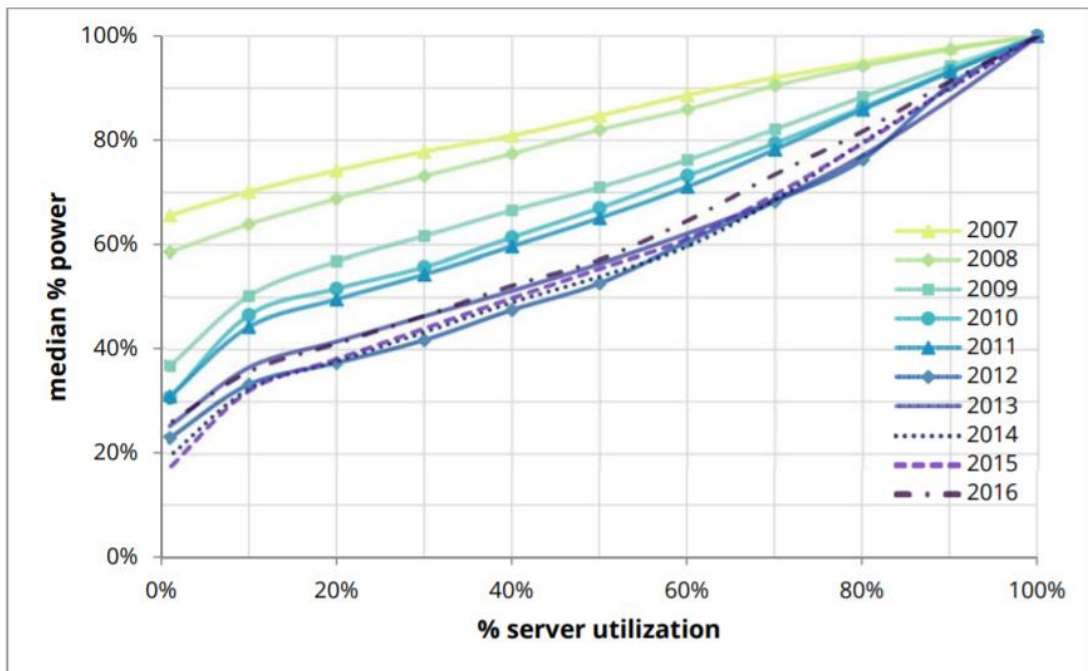

Figure 23. Comparison of typical server load factor and utilization, 2007 to 2016

When utilization is low, the base power consumption and related heat dissipation are still fairly high even with the newest generation of hardware (20%+). Ideally, a higher level of server utilization (above 60%) would optimize overall compute efficiency relative to power consumption. However, it is also recognized that some data center operators want to provide a level of headroom to accommodate demand peaks. Therefore, the recommendation under this criterion allows for this variance from ideal practice. As can be seen from the recommendation, the goal is to provide a reasonable range of operations while minimizing underutilized or “ghost” servers that bring down the overall efficiency of the data center.

Server Virtualization

Server virtualization is a key tool to increase server utilization and reliability. Virtualization includes the selection, installation, configuration, maintenance and management of the operating system, applications and virtualization software installed on the IT equipment. This includes all clients and any hypervisor, which is the software or firmware that creates and runs virtual machines.

Historically, businesses used different hardware (servers) for different applications, hence CPU utilization rates varied and often were very low (i.e., below 10%). Server virtualization allows a single physical server to act as multiple virtual machines (VM) running independent tasks and applications, rather than as dedicated physical servers for each application. Containerized computing takes the concept of virtualization one step further by allowing multiple “containers” of applications to run on a single server and operating system. These virtualization strategies can be critical to increasing the utilization of physical servers. Whatever form it takes, virtualization can provide security, isolation of workloads and higher utilization of physical servers or hosts by sharing hardware resources for multiple application workloads.

Server virtualization can be simple to track. Most management front ends provide such information. We recommend tracking the following virtualization metrics for increasing the overall efficiency of the IT infrastructure:

1. **% Virtualization**. Recommended >50% of the total servers running virtualization software.

$\% \text{ Virtualization} = 100 \times \frac{\text{the number of physical servers running with virtualization software}}{\text{the total number of physical servers}}$

2. **Server virtualization index (Vi)**. Recommended > 8 active VMs per core.

$V_i = \frac{\text{Total VMs across all physical servers minus idle VMs across all servers}}{\text{Total Physical Cores Available}}$

Note the ability to achieve a high Vi is application dependent. Therefore, like other metrics, it may be most useful to track performance over time rather than to compare one data center to another.

IT Equipment Monitoring

Requirements and recommendations for Metering and Monitoring are provided in the Electrical Systems Section. However, IT equipment (e.g., servers) are equipped with increasingly sophisticated sensors for monitoring environmental factors, power, and other performance and reliability indicators. These sensors can provide critical feedback on temperature, airflow, power, and other data. These data can be used at multiple levels to optimize energy management for servers and IT loads overall. For this reason, we recommend

operators collect sensor data and, at Level III, automate data collection and potential control responses into the data center's Building Management System (BMS).

Resources

Characteristics and Energy Use of Volume Servers in the United States. LBNL. October 2017. This paper explores various characteristics of 1- and 2-socket volume servers that affect energy consumption and quantifies the difference in power demand between higher-performing SPEC and ENERGY STAR servers and our best understanding of a typical server operating today. This resource covers general characteristics of the U.S. installed base of volume servers from existing IDC data and the literature, trends in power draw across loads and results from surveys of the prevalence of more-efficient equipment and operational practices in server rooms and closets. [Link](#).

Efficiency Ratings for Servers. United States Department of Energy's (DOE) Environmental Protection Agency (EPA) released the final version of the "ENERGY STAR Version 3.0 on 17 September 2018 "Computer Servers Program Requirements" which defines the Active State Efficiency Thresholds that will determine ENERGY STAR eligibility effective June 17, 2019. The new thresholds have been determined using data collected by running the SERT Suite. [Link](#).

Server Efficiency Rating Tool (SERT) Design Document. The Server Efficiency Rating Tool (SERT) was created by the Standard Performance Evaluation Corporation (SPEC). SERT is a tool which evaluates energy efficiency of servers. The SERT was created with the input from leaders of various global energy-efficiency programs and their stakeholders in order to accommodate for their regional program requirements. [Link](#).

80 PLUS Power Supply Certification. Website, current. **Plug Load Solutions.** Power supplies are the devices that power computer, servers and data center devices. They convert AC power from electric utilities into data center power used in most electronics. The 80 PLUS® performance specification requires power supplies in computers and servers to be 80% or greater energy efficient at 10%, 20%, 50% and 100% of rated load with a true power factor of 0.9 or greater. This makes an 80 PLUS certified power supply substantially more efficient than typical power supplies. [Link](#).

380 VDC Architectures for the Modern Data Center. Report, 2013. EMerge Alliance. Presents an overview of the case for the application of 380 VDC as a vehicle for optimization and simplification of the critical electrical system in the modern data center. Specifically, this paper presents currently available architectures consistent with ANSI/BICSI 002-2011 and the EMerge Alliance Data/Telecom Center Standard Version 1.0. [Link](#).

Optimizing Resource Utilization of a Data Center. Report, 2016. Xiang Sun, Nirwan Ansari, Ruopeng Wang, IEEE. To provision IT solutions with reduced operating expenses, many businesses are moving their IT infrastructures into public data centers or start to build their own private data centers. Data centers can provide flexible resource provisioning in order to accommodate the workload demand. In this paper, we present a comprehensive survey of most relevant research activities on resource management of data centers that aim to optimize the resource utilization. [Link](#).

Analyzing Utilization Rates In Data Centers for Optimizing Energy Management. Report, 2012. Michael Pawlish, Aparna Varde, Stefan Robila, Montclair State University. Explores academic data center utilization rates from an energy management perspective with the broader goal of providing decision support for green computing. [Link](#).

Data Center Case Study: How Cisco IT Virtualizes Data Center Application Servers. Report, 2007. Cisco Systems Inc. Deploying virtualized servers produces significant cost savings, lowers demand for data center resources, and reduces server deployment time. [Link](#).

Implementing and Expanding a Virtualized Environment. Report, 2010. Bill Sunderland, Steve Anderson, Intel. In 2005, Intel IT began planning, engineering, and implementing a virtualized business computing production environment as part of our overall data center strategy. [Link](#).

Data Center IT Efficiency Measures. Guide, 2015. NREL. The Uniform Methods Project: Methods for Determining Energy Efficiency Savings for Specific Measures. [Link](#).

6. Additional Resources

DC Pro. Online tool, current. Lawrence Berkeley National Laboratory. This 10-screen online tool estimates current and potential PUE and energy use distribution without sub-metering. DC Pro also provides tailored recommended actions to start the improvement process. An especially valuable output of this tool is an estimated Power Usage Effectiveness (PUE) metric. [Link](#).

PUE Estimator. Online tool, current. Lawrence Berkeley National Laboratory. This 1-screen online tool is a simplified version of DC Pro. The PUE Estimator only asks questions that affect the PUE calculation, and it does not provide potential PUE or recommended actions. [Link](#).

Data Center Best Practices Guide. Guide, 2012. Integral Group Inc, Lawrence Berkeley National Laboratory. Data centers can consume 100 to 200 times as much electricity as standard office spaces. With such large power consumption, they are prime targets for energy efficient design measures that can save money and reduce electricity use. However, the critical nature of data center loads elevates many design criteria -- chiefly reliability and high power density capacity -- far above efficiency. Short design cycles often leave little time to fully assess efficient design opportunities or consider first cost versus life cycle cost issues. This can lead to designs that are simply scaled up versions of standard office space approaches or that reuse strategies and specifications that worked "good enough" in the past without regard for energy performance. This Data Center Best Practices Guide has been created to provide viable alternatives to inefficient data center design and operating practices and address energy efficiency retrofit opportunities. [Link](#).

ASHRAE 90.4-2016: Energy Standard for Data Centers. Standard, 2016. ASHRAE. [Link](#).

Best Practices Guide for Energy-Efficient Data Center Design. Guide, 2011. William Lintner, Bill Tschudi, Otto VanGeet, US DOE EERE. This guide provides an overview of best practices for energy-efficient data center design which spans the categories of Information Technology (IT) systems and their environmental conditions, data center air management, cooling and electrical systems, on-site generation, and heat recovery. [Link](#).

Data Center Knowledge. Website, current Informa. From the website: "Data Center Knowledge is a leading online source of daily news and analysis about the data center industry." [Link](#).

Energy Star: Data Center Equipment. Website, current US Energy Star Program. Data centers are often thought of as large standalone structures run by tech giants. However, it is the smaller data center spaces located in almost every commercial building -- such as localized data centers, server rooms and closets -- that can also waste a lot of energy. Here are the best resources to help you save energy in your data center -- be it large or small. [Link](#).

Reducing Data Center Loads for a Largescale, Low-energy Office Building: NREL's Research Support Facility. Report, 2011. Michael Sheppy, Chad Lobato, Otto Van Geet, Shanti Pless, Kevin Donovan, Chuck Powers, NREL. In June 2010, the National Renewable Energy Laboratory (NREL) completed construction on the new 220,000-square foot (ft²) Research Support Facility (RSF) which included a 1,900-ft² data center (the RSF will expand to 360,000 ft² with the opening of an additional wing December 2011). The project's request for proposals (RFP) set a whole-building demand-side energy use requirement of a nominal 35 kBtu/ft² per year. On-site renewable energy generation offsets the annual energy consumption. The original "legacy" data center had annual energy consumption as high as 2,394,000 kilowatt-hours (kWh), which would have exceeded the total building energy goal. As part of meeting the building energy goal, the RSF data center annual energy use had to be approximately 50% less than the legacy data center's annual energy use. This report

documents the methodology used to procure, construct, and operate an energy-efficient data center suitable for a net-zero energy-use building. [Link](#).

Best Practices for Data Centers: Lessons Learned From Benchmarking 22 Data Centers. Report, 2006. Steve Greenberg, Evan Mills, Bill Tschudi, Lawrence Berkeley National Laboratory. Peter Rumsey, Rumsey Engineers. Bruce Myatt, EYP Mission Critical Facilities.

Over the past few years, the authors benchmarked 22 data center buildings. From this effort, we have determined that data centers can be over 40 times as energy intensive as conventional office buildings. Studying the more efficient of these facilities enabled us to compile a set of “best-practice” technologies for energy efficiency. These best practices include: improved air management, emphasizing control and isolation of hot and cold air streams; rightsizing central plants and ventilation systems to operate efficiently both at inception and as the data center load increases over time; optimized central chiller plants, designed and controlled to maximize overall cooling plant efficiency, central air-handling units, in lieu of distributed units; “free cooling” from either air-side or water-side economizers; alternative humidity control, including elimination of control conflicts and the use of direct evaporative cooling; improved uninterruptible power supplies; high-efficiency computer power supplies; on-site generation combined with special chillers for cooling using the waste heat; direct liquid cooling of racks or computers; and lowering the standby losses of standby generation systems. [Link](#).

ASHRAE Datacom Series of Books. The Datacom Series provides a comprehensive treatment of data center cooling and related subjects, authored by ASHRAE Technical Committee 9.9, Mission Critical Facilities, Data Centers, Technology Spaces and Electronic Equipment. Series titles include: Thermal Guidelines for Data Processing Environments; IT Equipment Power Trends; Design Considerations for Datacom Equipment Centers; Liquid Cooling Guidelines for Datacom Equipment Centers; Best Practices for Datacom Facility Energy Efficiency; Real-Time Energy Consumption Measurements in Data Centers; and Server Efficiency - Metrics for Computer Servers and Storage. [Link](#).

Accelerating Energy Efficiency In Indian Data Centers: Final Report for Phase I Activities. Report, 2016. Suprotim Ganguly, Sanyukta Raje, Satish Kumar, Confederation of Indian Industry. Dale Sartor, Steve Greenberg, Lawrence Berkeley National Laboratory. This report documents Phase 1 of the “Accelerating Energy Efficiency in Indian Data Centers” initiative to support the development of an energy efficiency policy framework for Indian data centers. The initiative is being led by the Confederation of Indian Industry (CII), in collaboration with Lawrence Berkeley National Laboratory/U.S. Department of Energy’s Office of Energy Efficiency and Renewable Energy, and under the guidance of Bureau of Energy Efficiency (BEE). It is also part of the larger Power and Energy Efficiency Working Group of the US-India Bilateral Energy Dialogue. The initiative consists of two phases: Phase 1 (November 2014 – September 2015) and Phase 2 (October 2015 – September 2016). [Link](#).

Small Data Centers, Big Energy Savings: An Introduction for Owners and Operators. Guide, 2017. Steve Greenberg, Magnus Herrlin, Lawrence Berkeley National Laboratory.

Significant untapped energy efficiency potential exists within small data centers (under 5,000 square feet of computer floor space). While small on an individual basis, these data centers collectively house more than half of all servers (Shehabi et al 2016) and consume about 40 billion kWh per year. Owners and operators of small data centers often lack the resources to assess, identify and implement energy-saving opportunities. As a result, energy performance for this category of data centers has been below average.

The purpose of this brief guide is to present opportunities for small data center owners and operators that generally make sense and do not need expensive assessment and analysis to justify. Recommendations presented in this report range from very simple measures that require no capital investment and little ongoing effort to measures that do need some upfront funds and time to implement. Typical energy savings in data centers where these measures have been implemented have been in the range of 20% to 40%. The energy efficiency measures presented have been shown to work with no impact on IT equipment reliability, when implemented carefully and appropriately. Do make sure to take the appropriate precautions when considering these measures at your own data centers. Check the IT equipment intake air temperatures to make sure they are prudent, for example, to ensure no negative reliability impacts.

In addition to covering the most-common energy-saving opportunities, this guide notes the value of training for personnel involved in data center operations and management. References are also provided for further information. [Link](#).

2018 Best Practice Guidelines for the EU Code of Conduct on Data Center Energy Efficiency. The present report supplement to the Code of Conduct and present the updated (2018) version of the Best Practices. This report is provided as an education and reference document as part of the Code of Conduct to assist data center operators in identifying and implementing measures to improve the energy efficiency of their data centers. A broad group of expert reviewers from operators, vendors, consultants, academics, professional and national bodies have contributed to and reviewed the Best Practices. [Link](#).

ISO 22237 Series and The European Standard EN 50600 Series (A replica of the ISO 22237 series as listed below). Multiple standards/technical specifications published starting in 2013 addressing data center design, build, and operations. [Link](#). Also see ISO/IEC JTC 1/SC 39 committee at [Link](#).

International standards are voluntary; there is no compulsion to adopt any standard unless required by legislation or regulation. That said, the use of voluntary standards may be applied by commercial or public entities to select suitable contractors or suppliers of services. It is therefore recommended that organizations operating in this field ensure that they make enquires to local procurement bodies or review tender documents to ascertain whether conformance or certification to a specific standard is required.

Relevant standards and technical reports include:

- EN50600-1 General Concepts (ISO22237-1)
- EN50600-2-1 Building Construction (ISO22237-2)
- EN50600-2-2 Power (ISO22237-3)
- EN50600-2-3 Environmental Control (ISO22237-4)
- EN50600-2-4 Telecommunications Cabling Infrastructure (ISO22237-5)
- EN 50600-2-5 Security Systems (ISO22237-6)
- EN 50600-3-1 Management and operational information (ISO22237-7)

Data Center KPI's:

- ISO 30134-1 Overview and general requirements (EN50600-4-1)
- ISO 30134-2 PUE (EN50600-4-2)
- ISO 30134-3 REF (EN50600-4-3)
- ISO 30134-4 ITEEsv (EN50600-4-4)
- ISO 30134-5 ITEUsv (EN50600-4-5)
- ISO 30134-6 ERF (EN50600-4-6)
- ISO 30134-7 CER (EN50600-4-7)

Technical Reports:

EN 50600 TR-99-1 Energy best practices

EN 50600 TR-99-2 Sustainability best practices

EN 50600 TR-99-3 Guidance to the application of the EN50600 series

EN50600 TR99-4 (In preparation) Data Center Maturity Model

Shining a Light On Small Data Centers In the U.S. Small data centers consume 13 billion kWh of energy annually, emitting 7 million metric tons (MMT) of carbon dioxide—the equivalent emissions of approximately 2.3 coal-fired plants. It is important to evaluate energy efficiency potential in small data centers. [Link](#).

Energy Efficiency Guidelines and Best Practices In Indian Datacenters. Report, 2010. Bureau of Energy Efficiency, India. This manual contains the following:

- Information about the latest trends & technologies in data centers and its associated systems
- The best practices adopted in various data centers for improving energy efficiency levels.
- Case studies elucidating the technical details and the financial benefits of adopting certain measures for higher energy efficiency.
- Guidelines for setting up energy efficient data centers.
- Key indicators to assess the performance of existing systems.
- Information to set section-wise targets for energy conservation goals.

For further details, visit [Link](#).

Appendix A: Glossary

AHRI	Air-conditioning, Heating, and Refrigeration Institute.
ASHRAE	American Society of Heating, Refrigerating and Air Conditioning Engineers.
BEE	Bureau of Energy Efficiency, Indian Ministry of Power.
BMS	Building Management System.
CoE	Center of Expertise for Energy Efficiency in Data Centers, http://datacenters.lbl.gov .
COP	Coefficient of Performance. For cooling equipment this is defined as the ratio of total cooling provided (including latent cooling, and ignoring fan motor heat), to electrical input power, at a given rating condition. Both the cooling and the input power are expressed in the same units, yielding a dimensionless number.
CRAC	Computer Room Air Conditioner. A Direct-Expansion (DX) system for providing temperature and humidity control in data Centers.
CRAH	Computer Room Air Handler. A chilled-water system for providing temperature and humidity control in data Centers.
ECBC	Energy Conservation Building Code.
ECM	Electrically Commutated Motor.
kVAR	Kilo-Volt-Amps, Reactive.
kVARh	Kilo-Volt-Amp Hours, Reactive.
kW	Kilowatt
kWh	Kilowatt-hour
Net Sensible Cooling Capacity	Total gross cooling capacity less latent cooling capacity & fan power
NSenCOP	Net Sensible Coefficient of Performance. The ratio of Net Sensible Cooling provided (which is equal to total cooling, minus latent cooling, minus fan input power) to electrical input power, at a given rating condition. See also COP and SCOP.
PDU	Power Distribution Unit.
PUE	Power Usage Effectiveness, ratio of total building energy to IT equipment energy.
SCOP	Sensible Coefficient of Performance. The ratio of Sensible Cooling provided (which is equal to total cooling minus latent cooling) to electrical input power, at a given rating condition. See also COP and NSenCOP.
UPS	Uninterruptible Power Supply.
VAV	Variable Air Volume.
VSD	Variable Speed Drive
VFD	Variable Frequency Drive.

Confederation of Indian Industry (CII)

CII works to create and sustain an environment conducive to the development of India, partnering industry, government, and civil society, through advisory and consultative processes.

CII is a non-government, not-for-profit, industry-led and industry-managed organization, playing a proactive role in India's development process. Founded in 1895, India's premier business association has around 9,000 members, from the private as well as public sectors, including SMEs and MNCs, and an indirect membership of over 300,000 enterprises from around 276 national and regional sectoral industry bodies.

Indian Green Building Council (IGBC)

The Indian Green Building Council (IGBC), part of the CII was formed in the year 2001. The vision of the council is, "To enable a sustainable built environment for all and facilitate India to be one of the global leaders in the sustainable built environment by 2025".

Lawrence Berkeley National Laboratory (LBNL)

LBNL, also commonly referred to as Berkeley Lab, is a United States national laboratory that conducts scientific research on behalf of the United State's Department of Energy (DOE).

The Department of Energy-led Center of Expertise for Energy Efficiency in Data Centers (CoE) demonstrates national leadership in decreasing the energy use of data centers. Through the supply of technical support, tools, best practices, analyses, and the introduction of technologies, CoE assists federal agencies and other organizations implement data center energy efficiency projects. The CoE partners with key public and private stakeholders to further efficiency efforts.



Confederation of Indian Industry
125 Years - Since 1895



Confederation
of Indian Industry
info@cii.in
www.cii.in

Center of Expertise for Energy
Efficiency in Data Centers,
Lawrence Berkeley National
Laboratory
datacenters.lbl.gov

Indian Green
Building Council
IGBC datacenters